



2024

TEAM





- 1 STICKS
- 14 GLOVES
- 22 HELMETS
- 30 PANTS
- 34 BAGS
- 38 WOMEN'S APPAREL
- 41 MEN'S APPAREL
- 55 HEADWEAR
- 60 ACCESSORIES
- 62 GOALIE

WARRIOR SPORTS
7080 23 MILE RD.
SHELBY TOWNSHIP, MI. 48316 | U.S.A.

LEON DRAISAITL
EDMONTON OILERS



STICKS



**STICK
PERSONALIZATION
PROGRAM**

WHAT STICKS ARE INCLUDED?

Alpha LX2 Pro (SR-JR), Alpha LX2 (SR-INT), Alpha LX2 Team (SR-INT)
Covert QR6 Pro (SR-JR), Covert QR6 (SR-INT), Covert QR6 T (SR-INT)
Novium Pro (SR-JR)

YOUR

NAME

HERE

**75
FLEX
W03
SR**

HOW IT WORKS?

Customers will submit orders through their local Warrior Hockey retailer. The following information must be provided for the stick order: style, flex, blade pattern, stick hand and name wanted on the stick.

HOW TO SUBMIT THE ORDER:

Once the order is placed, please send the stick specs, name, and PO number to Warrior via customs@warrior.com.

WHAT IS THE TURNAROUND TIME?

Turnaround time for the names on sticks program is one week or less. Sticks can be shipped directly to the store for pick up or to the customer if desired.

COVERT QR6 PRO

EDGE TAPER | The angular edge taper drives flex energy through the hosel that magnifies power and quick release. Our unique geometry improves response and is more stable and plays stronger.

EDGE BLADE | New redesigned blade technology featuring a unique shape where the blade meets the ice. The Edge Blade design engages the stick like never before making it even easier to load for quick release shots. Our lightweight polymer blade core wrapped with Minimus Carbon 25, enhances puck feel and reduces blade fatigue.

MINIMUS CARBON 25 | A flat spread-tow material that optimizes strength by reducing fiber crimp and deformation in the composite layering. The custom weave is thin and light, yet extremely strong and resistant to damage.

P. L. 188 | A completely re-engineered construction that provides improved durability and weight reduction by using lower weight fibers and thermoplastic-toughened epoxy resin that creates the consistent level of balance, weight, and durability that our pro players expect.

D. G. SHAFT SHAPE | Flat side walls with rounded corners provides consistent feel and control for stickhandling, shooting, and passing.

OFFERINGS

<u>SENIOR LONG</u>	<u>SENIOR</u>	<u>INTERMEDIATE</u>
SR 63" 95 FLEX W03, W28, W88 QR6PL954	SR 60" 95 FLEX W03, W28, W88, M03, M28 QR6P954	INT 60" 65 FLEX W03, W28, W88, M03, M28 QR6P654
SR 63" 85 FLEX W03, W28, W88 QR6PL854	SR 60" 85 FLEX W03, W28, W88, M03, M28 QR6P854	INT 57" 55 FLEX W03, W28, W88, M03, M28 QR6P554
SR 63" 75 FLEX W03, W28, W88 QR6PL754	SR 60" 75 FLEX W03, W28, W88, M03, M28, M88 QR6P754	
	SR 60" 70 FLEX W03, W28, W88, M03, M28 QR6P704	
<u>JUNIOR</u>	<u>YOUTH</u>	
JR 54" 50 FLEX W03, W28, W88 QR6P504	YTH 47" 20 FLEX W03 QR6P204	
JR 52" 40 FLEX W03, W28, W88 QR6P404		
JR 49" 30 FLEX W03, W28, W88 QR6P304		

CORE TECHNOLOGY

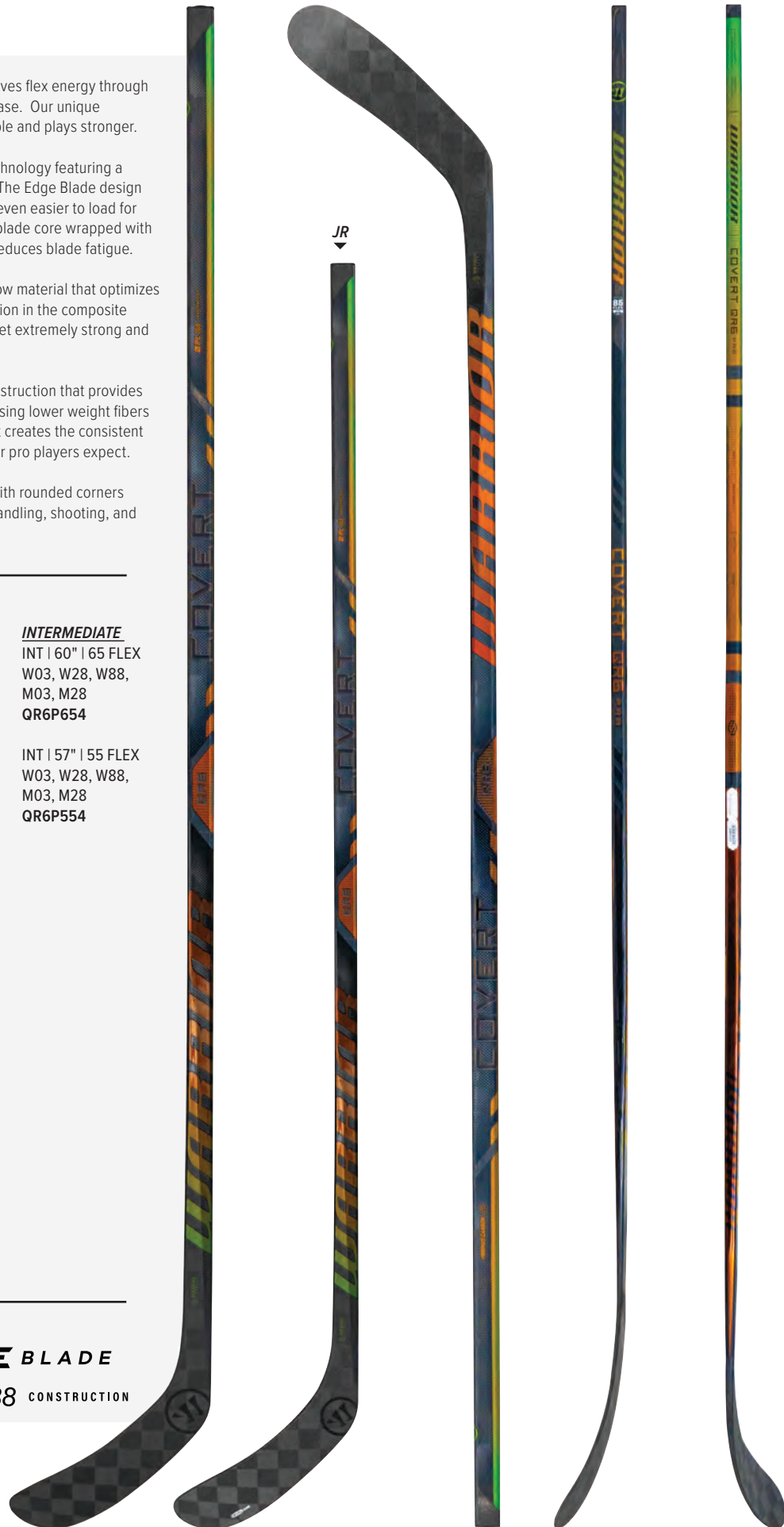

COVERT QR6

QR EDGE TAPER | The angular edge taper drives flex energy through the hosel that magnifies power and quick release. Our unique geometry improves response and is more stable and plays stronger.

MINIMUS CARBON 6 | Lightweight, high-strength carbon fiber weave that offers extreme toughness and durability.

L. 155 | Premium-grade construction that provides unmatched bending strength and impact resistance. A select blend of fibers and toughened resin chemistry brings weight reduction without sacrificing the elite level of balance and durability.

FUEL CORE | A lightweight polymer blade core that enhances puck feel and makes shots pop. Minimus Carbon 6 composite layering around the core is redesigned to be stronger, reducing breakdown of materials in the blade and increasing the durability.

D. G. SHAFT SHAPE | Flat side walls with rounded corners provides consistent feel and control for stickhandling, shooting, and passing.

OFFERINGS

<u>SENIOR</u>	<u>INTERMEDIATE</u>	<u>JUNIOR</u>
SR 60" 95 FLEX W03, W28, W88, M03, M28 QR6954	INT 60" 65 FLEX W03, W28, W88, M03, M28 QR6654	JR 54" 50 FLEX W03, W28, W88 QR6504
SR 60" 85 FLEX W03, W28, W88, M03, M28 QR6854	INT 57" 55 FLEX W03, W28, W88, M03, M28 QR6554	JR 52" 40 FLEX W03, W28, W88 QR6404
SR 60" 75 FLEX W03, W28, W88, M03, M28 QR6754		
SR 60" 70 FLEX W03, W28, W88, M03, M28 QR6704		

CORE TECHNOLOGY



COVERT QR6 T

QR EDGE TAPER | The angular edge taper drives flex energy through the hosel that magnifies power and quick release. Our unique geometry improves response and is more stable and plays stronger.

MINIMUS CARBON UD | Lighter and tougher than ever. Using unidirectional carbon fiber creates the most efficient lightweight and durable hockey stick.

T. L. 133 | High-grade carbon construction that features the latest lightweight fiber technology and epoxy resin formulation to provide lower weight with increased strength.

FUEL CORE | A lightweight polymer blade core that enhances puck feel and makes shots pop. Minimus Carbon 12 composite layering around the core is redesigned to be stronger, reducing breakdown of materials in the blade and increasing the durability.

D. G. SHAFT SHAPE | Flat side walls with rounded corners provides consistent feel and control for stickhandling, shooting, and passing.

OFFERINGS

<u>SENIOR</u>	<u>INTERMEDIATE</u>
SR 63" 105 FLEX W01, W02, W03, W05, W28, W88 QR6T1054	INT 60" 65 FLEX W03, W28, W88 QR6T654
SR 63" 95 FLEX W01, W02, W03, W05, W28, W88 QR6T954	INT 57" 55 FLEX W03, W28, W88 QR6T554
SR 63" 85 FLEX W01, W02, W03, W05, W28, W88 QR6T854	
SR 63" 75 FLEX W01, W02, W03, W05, W28, W88 QR6T854	
SR 63" 70 FLEX W01, W02, W03, W05, W28, W88 QR6T704	

CORE TECHNOLOGY



ALPHA LX2 PRO

SABRE TAPER | Exclusive taper provides a stable, powerful, and controlled release with pinpoint accuracy on hard shots. Designed and built for players that need reliable accuracy from anywhere.

ERGO SHAFT SHAPE | The ergonomic contoured shaft fits comfortably and securely in your hands, enhancing touch and feel for better deking, dragging, and shooting.

R.L.C. 188 | Revolutionary Lightweight Construction 188 uses the most advanced material selection and processing technologies to produce an extremely lightweight and durable stick.

MINIMUS CARBON 25 | This carbon weave is a flat, spread-tow material that optimizes strength by reducing fiber crimp and deformation in the composite layering. The custom weave is thin and light, yet extremely strong and resistant to damage.

FUELCORE ULTRA | Proprietary blade core material and layup structure maintains crisp and solid puck feel throughout the life of the stick. The polymer blade core is wrapped with high-grade carbon fiber and Minimus Carbon 25 outer weave. Texture on the blade surface increases grip on the puck.

APEX GRIP TEXTURE | Textured shaft surface coupled with a tacky soft grip finish locks easily in your hands for peak control and accuracy.

OFFERINGS

SENIOR LONG

SR | 63" | 95 FLEX
W03, W28, W88
LX2PL953

SR | 63" | 85 FLEX
W03, W28, W88
LX2PL853

SR | 63" | 75 FLEX
W03, W28, W88
LX2PL753

JUNIOR

JR | 54" | 50 FLEX
W03, W28, W88
LX2P503

JR | 51" | 40 FLEX
W03, W28, W88
LX2P403

JR | 49" | 30 FLEX
W03, W28, W88
LX2P303

SENIOR

SR | 60" | 95 FLEX
W01, W02, W03,
W05, W28, W88,
M03, M28, M88
LX2P953

SR | 60" | 85 FLEX
W01, W02, W03,
W05, W28, W88,
M03, M28, M88
LX2P853

SR | 60" | 75 FLEX
W01, W02, W03,
W05, W28, W88,
M03, M28, M88
LX2P753

SR | 60" | 65 FLEX
W01, W02, W03,
W05, W28, W88,
M03, M28, M88
LX2P653

INTERMEDIATE

INT | 60" | 70 FLEX
W03, W28, W88,
M03, M28, M88
LX2P703

INT | 60" | 63 FLEX
W03, W28, W88,
M03, M28, M88
LX2P633

INT | 57" | 55 FLEX
W03, W28, W88,
M03, M28, M88
LX2P553

YOUTH

JR | 48" | 20 FLEX
W03
LX2P2

CORE TECHNOLOGY



ALPHA LX2

SABRE TAPER | Our exclusive taper provides a stable, powerful, and controlled release with pinpoint accuracy on hard shots. Designed and built for players that need reliable accuracy from anywhere, and dependable stability when shooting.

ERGO SHAFT SHAPE | The ergonomic contoured shaft fits comfortably and securely in your hands, enhancing touch and feel for better deking, dragging, and shooting.

R.L.C. 155 | Revolutionary Lightweight Construction 155 is a premium grade carbon construction that provides the ultimate in bending strength and impact resistance. A select blend of high elongation fibers and toughened resin chemistry that provides pro-level strength and performance.

MINIMUS CARBON 6 | Lightweight, high-strength carbon fiber weave that offers extreme toughness and durability.

FUELCORE PRO | Our lightweight polymer blade core that enhances puck feel and makes shots pop. Now with Minimus Carbon 6 weave around the core is lightweight and strong. Texture on the blade increases the feel for the puck.

APEX GRIP | Tacky soft grip finish on shaft that prevents alippage and improves control.

OFFERING

SENIOR

SR | 63" | 95 FLEX
W01, W02, W03,
W05, W28, W88,
M03, M28, M88
LX2953

SR | 63" | 85 FLEX
W01, W02, W03,
W05, W28, W88,
M03, M28, M88
LX2853

SR | 63" | 75 FLEX
W01, W02, W03,
W05, W28, W88,
M03, M28, M88
LX2753

SR | 63" | 65 FLEX
W01, W02, W03,
W05, W28, W88,
M03, M28, M88
LX2653

INTERMEDIATE

INT | 63" | 70 FLEX
W03, W28, W88,
M03, M28, M88
LX2703

INT | 60" | 63 FLEX
W03, W28, W88,
M03, M28, M88
LX2633

INT | 57" | 55 FLEX
W03, W28, W88,
M03, M28, M88
LX2553

JUNIOR

JR | 54" | 50 FLEX
W03, W28, W88
LX2503

JR | 51" | 40 FLEX
W03, W28, W88
LX2403

CORE TECHNOLOGY



ALPHA LX2 TEAM

SABRE TAPER | Our exclusive taper provides a stable, powerful, and controlled release with pinpoint accuracy on hard shots. Designed and built for players that need reliable accuracy from anywhere, and dependable stability when shooting.

R.L.C. 133 | Revolutionary Lightweight Construction 133 is a high-grade carbon construction that features the latest lightweight fiber technology and epoxy resin formulation to provide the ultimate in strength and playability.

MINIMUS CARBON UD | Unidirectional carbon fiber layer that is light and strong. The fiber orientation is perfectly aligned in an ultra-thin sheet that enhances flex response during shots.

FUELCORE | A lightweight polymer blade core that enhances puck feel and makes shots pop. Minimus Carbon 12 composite layering around the core is redesigned to be stronger and tougher. FuelCore reduces breakdown of materials in the blade and increases the durability.

ERGO SHAFT SHAPE | The ergonomic contoured shaft fits comfortably and securely in your hands, enhancing touch and feel for better deking, dragging, and shooting.

APEX GRIP TEXTURE | A textured zone coupled with tacky soft grip finish locks easily in your hands for peak control and accuracy.

OFFERINGS

SENIOR

SR | 63" | 105 FLEX
W01, W02, W03,
W05, W28, W88,
LX2T1053

SR | 63" | 95 FLEX
W01, W02, W03,
W05, W28, W88,
LX2T953

SR | 63" | 85 FLEX
W01, W02, W03,
W05, W28, W88,
LX2T853

SR | 63" | 75 FLEX
W01, W02, W03,
W05, W28, W88,
LX2T753

SR | 63" | 65 FLEX
W01, W02, W03,
W05, W28, W88,
LX2T653

INTERMEDIATE

INT | 60" | 70 FLEX
W03, W28, W88
LX2T703

INT | 60" | 63 FLEX
W03, W28, W88
LX2T633

INT | 60" | 55 FLEX
W03, W28, W88
LX2T553

CORE TECHNOLOGY



NOVIUM PRO

BEVEL TAPER | The unique Bevel Taper is designed to be stiffer through the taper which provides increased control and improved velocity on shots.

MINIMUS CARBON 25 | This carbon weave is a flat, spread-tow material that optimizes strength by reducing fiber crimp and deformation in the composite layering. The custom weave is thin and light, yet extremely strong and resistant to damage.

R.L.C. 199 | Revolutionary Lightweight Construction 199 is our highest-grade construction and uses the most advanced material selection and processing technologies to produce our lightest weight stick. R.L.C. 199 combines the latest in modern carbon composites technology – using lower weight fibers and thermoplastic-toughened epoxy resin to provide velocity, feel, and control.

FUELCORE ULTRA | The polymer blade core is tough and durable and is wrapped with high-grade carbon fiber and our Minimus Carbon 25 outer weave which creates the most responsive blade in our line up.

OFFERINGS

SENIOR

SR | 60" | 100 FLEX
W03, W28, W88, M03
NP1002

SR | 60" | 85 FLEX
W03, W28, W88, M03
NP852

SR | 60" | 75 FLEX
W03, W28, W88, M03
NP752

INTERMEDIATE
INT | 60" | 63 FLEX
W03, W28, W88, M03
NP632

INT | 57" | 55 FLEX
W03, W28, W88, M03
NP552

JUNIOR
JR | 54" | 50 FLEX
W03, W28, W88, M03
NP502

JR | 51" | 40 FLEX
W03, W28, W88, M03
NP402
**AVAILABLE IN INCREASED JUNIOR BLADE SIZES*

CORE TECHNOLOGY



NOVIUM

BEVEL TAPER | The unique Bevel Taper is designed to be stiffer through the taper which provides increased control and improved velocity on shots.

MINIMUS CARBON UD | Novium shaft is lighter and tougher than ever. Using unidirectional carbon fiber creates the most efficient lightweight and durable hockey stick.

R.L.C. 133 | Revolutionary Lightweight Construction 133 is a high-grade carbon construction that features the latest lightweight fiber technology and epoxy resin formula to provide the ultimate in strength and playability.

FUELCORE | A lightweight polymer blade that enhances puck feel and makes shots pop. Composite layering around the core is redesigned to be stronger and tougher. FuelCore reduces breakdown of materials in the blade and increases the durability.

OFFERINGS

SENIOR
SR | 60" | 85 FLEX
W03, W28, W88
NOV852

SR | 60" | 75 FLEX
W03, W28, W88
NOV752

INTERMEDIATE
INT | 60" | 63 FLEX
W03, W28, W88
NOV632

INT | 57" | 55 FLEX
W03, W28, W88
NOV552

JUNIOR
JR | 54" | 50 FLEX
W03, W28, W88
NOV502

JR | 51" | 40 FLEX
W03, W28, W88
NOV402
**AVAILABLE IN INCREASED JUNIOR BLADE SIZES*

CORE TECHNOLOGY



WARRIOR BLADE PATTERN CHART

<p>W01</p> <p>WARRIOR CODE: 553 / 554</p> <p>COMPARE TO: BAUER PM9, CCM P14, TRUE MC2, LIE 3 (JR), 4</p> <p>LENGTH: Short FACE: Closed CURVE: Mid-Heel TOE: Round</p>	<p>W02</p> <p>WARRIOR CODE: 135</p> <p>COMPARE TO: BAUER P02, CCM P20, TRUE HCS, LIE 5</p> <p>LENGTH: Long FACE: Open CURVE: Mid-Heel TOE: Square</p>	<p>W03</p> <p>WARRIOR CODE: 694 / 695</p> <p>COMPARE TO: BAUER P92, CCM P29, TRUE TC2 / TC2.5, LIE 4 (JR), 5</p> <p>LENGTH: Medium FACE: Open CURVE: Mid TOE: Round</p>
<p>W05</p> <p>WARRIOR CODE: 205</p> <p>COMPARE TO: BAUER P91A, CCM P15, TRUE HCR, LIE 5</p> <p>LENGTH: Long FACE: Open CURVE: Heel TOE: Round</p>	<p>W28</p> <p>WARRIOR CODE: 114</p> <p>COMPARE TO: BAUER P28, CCM P28, TRUE TC4, LIE 4</p> <p>LENGTH: Medium FACE: Open CURVE: Mid-Toe TOE: Round</p>	<p>W88</p> <p>WARRIOR CODE: 933 / 934</p> <p>COMPARE TO: BAUER P88, CCM P30, TRUE MC, LIE 4 (JR), 5</p> <p>LENGTH: Medium FACE: Closed CURVE: Mid TOE: Semi-square</p>
<p>M03</p> <p>W03 + MAX HEIGHT WARRIOR CODE: 696 / 697</p> <p>COMPARE TO: BAUER P92, CCM P29, TRUE TC2 / TC 2.5, LIE 4 (JR), 5</p> <p>LENGTH: Medium FACE: Open CURVE: Mid TOE: Round</p>	<p>M28</p> <p>W28 + MAX HEIGHT WARRIOR CODE: 115</p> <p>COMPARE TO: BAUER P28, CCM P28, TRUE TC4, LIE 4</p> <p>LENGTH: Medium FACE: Open CURVE: Mid-Toe TOE: Round</p>	<p>M88</p> <p>W88 + MAX HEIGHT WARRIOR CODE: 935 / 936</p> <p>COMPARE TO: BAUER P88, CCM P30, TRUE MC, LIE 4 (JR), 5</p> <p>LENGTH: Medium FACE: Closed CURVE: Mid TOE: Semi-square</p>

COVERT QR6 STICK OVERVIEW

STYLE	FLEX	LENGTH	BLADE PATTERN										
			W01	W02	W03	W05	W28	W88	M03MAX	M28MAX	M88MAX		
QR6 PRO	QR6 PRO LONG	95, 85, 75	63"			●			●	●			
	QR6 PRO SR	95, 85, 75, 70	60"			●			●	●	●	●	
	QR6 PRO INT	65	60"			●			●	●	●	●	
	QR6 PRO INT	55	57"			●			●	●	●	●	
	QR6 PRO JR	50	54"			●			●	●	●	●	
	QR6 PRO JR	40	52"			●			●	●	●	●	
	QR6 PRO JR	30	49"			●			●	●	●	●	
	QR6 PRO YTH	20	47"			●			●	●	●	●	
QR6	QR6 SR	95, 85, 75, 70	60"			●			●	●	●	●	
	QR6 INT	65	60"			●			●	●	●	●	
	QR6 INT	55	57"			●			●	●	●	●	
	QR6 JR	50	54"			●			●	●	●	●	
	QR6 JR	40	52"			●			●	●	●	●	
QR6 T	QR6 T SR	105, 95, 85, 75, 70	63"	●	●	●	●	●	●	●	●	●	
	QR6 T INT	65	60"			●			●	●	●	●	
	QR6 T INT	55	57"			●			●	●	●	●	

ALPHA LX2 STICK OVERVIEW

STYLE	FLEX	LENGTH	BLADE PATTERN										
			W01	W02	W03	W05	W28	W88	M03MAX	M28MAX	M88MAX		
LX2 PRO	LX2 PRO LONG	95, 85, 75	63"			●			●	●			
	LX2 PRO SR	95, 85, 75, 65	60"	●	●	●	●	●	●	●	●	●	●
	LX2 PRO INT	70, 63	60"			●			●	●	●	●	●
	LX2 PRO INT	55	57"			●			●	●	●	●	●
	LX2 PRO JR	50	54"			●			●	●	●	●	●
	LX2 PRO JR	40	51"			●			●	●	●	●	●
	LX2 PRO JR	30	49"			●			●	●	●	●	●
	LX2 PRO YTH	20	47"			●			●	●	●	●	●
LX2	LX2 SR	95, 85, 75	63"	●	●	●	●	●	●	●	●	●	●
	LX2 INT	70, 63	60"			●			●	●	●	●	●
	LX2 INT	55	57"			●			●	●	●	●	●
	LX2 JR	50	54"			●			●	●	●	●	●
	LX2 JR	40	51"			●			●	●	●	●	●
LX2 TEAM	LX2 TEAM SR	105, 95, 85, 75, 65	63"	●	●	●	●	●	●	●	●	●	●
	LX2 TEAM INT	70, 63	60"			●			●	●	●	●	●
	LX2 TEAM INT	55	57"			●			●	●	●	●	●

NOVIUM STICK OVERVIEW

STYLE	FLEX	LENGTH	BLADE PATTERN										
			W01	W02	W03	W05	W28	W88	M03MAX	M28MAX	M88MAX		
NOVIUM PRO	PRO SR	100, 85, 75	60"			●			●	●	●	●	
	PRO INT	63	60"			●			●	●	●	●	
	PRO INT	55	57"			●			●	●	●	●	
	PRO JR	50	54"			●			●	●	●	●	
	PRO JR	40	51"			●			●	●	●	●	
NOVIUM	NOVIUM SR	85, 75	60"			●			●	●	●	●	
	NOVIUM INT	63	60"			●			●	●	●	●	
	NOVIUM INT	55	57"			●			●	●	●	●	
	NOVIUM JR	50	54"			●			●	●	●	●	
	NOVIUM JR	40	51"			●			●	●	●	●	





BRANDON MONTOUR
FLORIDA PANTHERS

COVERT

PRO TEAM GLOVE

Visit our customizer and build your own: <http://www.warrior.com/CustomHockeyGloves>



- Multi-Zone Custom Coloring
- 2-Color Embroidered Cuff Roll
- Pro Segmented Covert Taper Fit
- Team Logo Embroidery (name or number)
- 3D WARRIOR Lettering also available on cuff
- Axi Flex Thumb
- Fits similar to inline Covert QR6 Pro and QR6 Gloves

STYLE CODES | SIZES

C-CPGSR3 13, 14, 15 [SENIOR]
C-CPGJR3 10, 11, 12 [JUNIOR]

ALSO AVAILABLE IN COVERT PRO PLUS TEAM GLOVE

CONTACT YOUR WARRIOR SALES REP FOR MORE INFORMATION

ZONES 1, 2, 3, 4 BK WH NV DRL LRL RD OR SG FG KG MR

LOGOS / BRANDING BK WH NV DRL LRL RD OR SG FG KG MR

GR CAR PHX PU YL TL NG VG BR PK

BINDING BK WH NV DRL LRL RD OR MR

BK (Black), WH (White), NV (Navy), DRL (Dark Royal), LRL (Light Royal), RD (Red), OR (Orange), SG (Sport Gold), FG (Forest Green), KG (Kelly Green), MR (Maroon), GR (Grey), CAR (Carolina Blue), PHX (Phoenix), PU (Purple), YL (Yellow), TL (Teal), NG (Neon Green), VG (Vegas Gold), BR (Brown), PK (Pink)

CUSTOM COLOR ZONES

ZONE 1 FINGER COLOR



ZONE 2 BASE COLOR



ZONE 3 CUFF ROLL



ZONE 4 UPPER CUFF



ALPHA

PRO TEAM GLOVE

Visit our customizer and build your own: <http://www.warrior.com/CustomHockeyGloves>

ALPHA

CLASSIC PRO TEAM GLOVE

Visit our customizer and build your own: <http://www.warrior.com/CustomHockeyGloves>

ALPHA GLOVES



- Multi-Zone Custom Coloring
- 2-Color Embroidered Cuff Roll
- Pro Segmented Covert Taper Fit
- Team Logo Embroidery (name or number)
- 3D WARRIOR Lettering also available on cuff
- Axi Flex Thumb
- Fits similar to inline Alpha LX2 and LX2 MAX Gloves

STYLE CODES | SIZES

C-APGSR1	13, 14, 15	[SENIOR]
C-APGJR1	10, 11, 12	[JUNIOR]

ALSO AVAILABLE IN ALPHA PRO PLUS TEAM GLOVE

CONTACT YOUR WARRIOR SALES REP FOR MORE INFORMATION

ZONES 1, 2, 3, 4 BK WH NV DRL LRL RD OR SG FG KG MR

LOGOS / BRANDING BK WH NV DRL LRL RD OR SG FG KG MR
GR CAR PHX PU YL TL NG VG BR PK

BINDING BK WH NV LRL RD SG MR

BK (Black), WH (White), NV (Navy), DRL (Dark Royal), LRL (Light Royal), RD (Red), OR (Orange), SG (Sport Gold), FG (Forest Green), KG (Kelly Green), MR (Maroon), GR (Grey), CAR (Carolina Blue), PHX (Phoenix), PU (Purple), YL (Yellow), TL (Teal), NG (Neon Green), VG (Vegas Gold), BR (Brown), PK (Pink)

CUSTOM COLOR ZONES

ZONE 1
BASE COLOR



ZONE 2
CUFF ROLL



ZONE 3
UPPER CUFF



ZONE 4
FINGER COLOR



ALPHA GLOVES



- Custom Coloring
- Team Name Embroidery
- Axi Flex Thumb
- Hybrid Taper Fit
- Premium Protection with full plastic inserts
- 3D WARRIOR Lettering also available on cuff
- Axi Flex Thumb
- Fits similar to inline Alpha FR2 Gloves

STYLE CODES | SIZES

C-ACPSR1	13, 14, 15	[SENIOR]
C-ACPGJR1	10, 11, 12	[JUNIOR]

CONTACT YOUR WARRIOR SALES REP FOR MORE INFORMATION

ZONES 1, 2, 3, 4 BK WH NV DRL LRL RD OR SG FG KG MR

LOGOS / BRANDING BK WH NV DRL LRL RD OR SG FG KG MR
GR CAR PHX PU YL TL NG VG BR PK

BINDING BK WH NV LRL RD SG MR

BK (Black), WH (White), NV (Navy), DRL (Dark Royal), LRL (Light Royal), RD (Red), OR (Orange), SG (Sport Gold), FG (Forest Green), KG (Kelly Green), MR (Maroon), GR (Grey), CAR (Carolina Blue), PHX (Phoenix), PU (Purple), YL (Yellow), TL (Teal), NG (Neon Green), VG (Vegas Gold), BR (Brown), PK (Pink)

CUSTOM COLOR ZONES

ZONE 1
THUMB/INDEX
FINGER COLOR



ZONE 2
CUFF/OUTSIDE
STRIPE COLOR



ZONE 3
CUFF ROLL



ZONE 4
MIDDLE
STRIPES



COVERT

TEAM GLOVE

Visit our customizer and build your own: <http://www.warrior.com/CustomHockeyGloves>

ALPHA

TEAM GLOVE

Visit our customizer and build your own: <http://www.warrior.com/CustomHockeyGloves>

COVERT GLOVES



- Custom Coloring
- Team Name Embroidery (name or number)
- Axi Flex Thumb
- Covert Taper Fit
- Premium Protection with full plastic inserts
- Fits similar to inline Covert QR6 T Gloves

STYLE CODES | SIZES

C-CTGSR3	13, 14, 15	[SENIOR]
C-CTGJR3	10, 11, 12	[JUNIOR]
C-CTGYH1	8, 9	[YOUTH]

CONTACT YOUR WARRIOR SALES REP FOR MORE INFORMATION

ZONES 1,2 BK WH NV DRL LRL RD OR SG FG KG MR

LOGOS / BRANDING BK WH NV DRL LRL RD OR SG FG KG MR
GR CAR PHX PU YL TL NG VG BR PK

BINDING BK WH NV LRL RD SG MR

BK (Black), WH (White), NV (Navy), DRL (Dark Royal), LRL (Light Royal), RD (Red), OR (Orange), SG (Sport Gold), FG (Forest Green), KG (Kelly Green), MR (Maroon), GR (Grey), CAR (Carolina Blue), PHX (Phoenix), PU (Purple), YL (Yellow), TL (Teal), NG (Neon Green), VG (Vegas Gold), BR (Brown), PK (Pink)

CUSTOM COLOR ZONES

ZONE 1 CUFF ROLL



ZONE 2 BASE COLOR



ALPHA GLOVES



- Custom Coloring
- Team Name Embroidery
- Axi Flex Thumb
- Hybrid Taper Fit
- Premium Protection with full plastic inserts
- Fits similar to inline Alpha LX2 MAX Gloves

STYLE CODES | SIZES

C-ATGSR1	13, 14, 15	[SENIOR]
C-ATGJR1	10, 11, 12	[JUNIOR]
C-ATGYH1	8, 9	[YOUTH]

CONTACT YOUR WARRIOR SALES REP FOR MORE INFORMATION

ZONES 1,2 BK WH NV DRL LRL RD OR SG FG KG MR

LOGOS / BRANDING BK WH NV DRL LRL RD OR SG FG KG MR
GR CAR PHX PU YL TL NG VG BR PK

BINDING BK WH NV LRL RD SG MR

BK (Black), WH (White), NV (Navy), DRL (Dark Royal), LRL (Light Royal), RD (Red), OR (Orange), SG (Sport Gold), FG (Forest Green), KG (Kelly Green), MR (Maroon), GR (Grey), CAR (Carolina Blue), PHX (Phoenix), PU (Purple), YL (Yellow), TL (Teal), NG (Neon Green), VG (Vegas Gold), BR (Brown), PK (Pink)

CUSTOM COLOR ZONES

ZONE 1 CUFF ROLL



ZONE 2 BASE COLOR



COVERT QR6 GLOVE



CORE TECHNOLOGY
COVERT
TAPER FIT

IMPAX
FOAM

DUO-LAM

AXYFLEX THUMB

WARTECH FNC LINER
Powered by Polygiene

PROPALM X

COVERT TAPER FIT | Glove contours and flexes with the natural shape of your hand to provide optimal control over every movement and the ultimate in mobility and protection.

AXYFLEX THUMB | Mobility and dexterity through the hand and fingers is enhanced with the AXYFlex Thumb and foam mesh gussets.

BUTTERSOFTEEL | Responsive Lycra gussets, AXYFLEX THUMB and anatomical stretch backhand give this glove a game ready feel right off the shelf.

EXO+ DUO - LAM | Extremely lightweight blend of 2 layers of foam, a HD VN and a mid-density foam combined with plastic inserts in the backhand, cuff, and fingers that keep your hands protected against the hardest of impacts.

PRO PALM X | A pro tested Ax Suede palm with embossed grip that offers a great mix of feel and durability.

WARTECH FNC LINER | Powered by Polygiene so you are always cool, dry and odor free - the very best stay fresh and clean.

STYLE CODES | SIZES

QR6GS4 13, 14, 15 [SENIOR]
QR6GJ4 10, 11, 12 [JUNIOR]

COLORS

BK (BLACK), BKW (BLACK/WHITE), NRW (NAVY/RED/WHITE), NV (NAVY), RD (RED), RL (ROYAL), RRW (ROYAL, RED, WHITE)



COVERT QR6 T GLOVE



CORE TECHNOLOGY
COVERT
TAPER FIT

AXYFLEX THUMB

PROPALM

DUO-LAM

COVERT TAPER FIT | Glove contours and flexes with the natural shape of your hand to provide optimal control over every movement and the ultimate in mobility and protection.

AXYFLEX THUMB | Mobility and dexterity through the hand and fingers is enhanced with the AXYFlex Thumb and foam mesh gussets.

BUTTERSOFTEEL | Responsive Lycra gussets, AXYFLEX THUMB and anatomical stretch backhand give this glove a game ready feel right off the shelf.

DUO - LAM | Extremely lightweight blend of 2 layers of foam, a HD VN and a mid-density foam combined with plastic inserts in the backhand, cuff, and fingers that keep your hands protected against the hardest of impacts.

PROPALM | A simple mix of feel and durability that enhances control.

STYLE CODES | SIZES

QR6TGS4 13, 14, 15 [SENIOR]
QR6TGJ4 10, 11, 12 [JUNIOR]

COLORS

BK (BLACK), BKO (BLACK/ORANGE), BKS (BLACK/SPORT GOLD), BKW (BLACK/WHITE), BRD (BLACK/RED), FG (FOREST GREEN), MR (MAROON), NRD (NAVY/RED), NSG (NAVY/SPORT GOLD), NV (NAVY), RD (RED), RL (ROYAL)



ALPHA LX2 MAX GLOVE



CORE TECHNOLOGY
ALPHA
HYBRID TAPER FIT

PROCUFF

PROPALM

WARTECH FNC LINER
Powered by Polygiene

DUO-LAM

HYBRID TAPER FIT | Allows the glove to contour to the natural shape of your hand, maximizing mobility and improving protection.

PRO CUFF | Extends your range of motion improving puck handling while still protecting your wrists from slashes.

BUTTERSOFTEEL | Responsive mesh gussets, a 3 piece finger, and our AXYFLEX THUMB accompanied by the anatomical stretch backhand give the LX2 Pro gloves a snappy, game ready feel right off the shelf.

DUO - LAMB | 2 layers of foam including HD VN and mid-density foams combined with plastic inserts in the backhand, cuff, and fingers that keep your hands protected.

PRO PALM | A pro tested Ax Suede palm with embossed grip

STYLE CODES | SIZES

LX2MGS3 13, 14, 15 [SENIOR]
LX2MGJ3 10, 11, 12 [JUNIOR]

COLORS

BK (BLACK), BKO (BLACK/ORANGE), BVG (BLACK/VEGAS GOLD), BKW (BLACK/WHITE), BRD (BLACK/RED), FG (FOREST GREEN), RL (ROYAL), NRD (NAVY/RED), NSG (NAVY SPORT GOLD), NV (NAVY), RD (RED), RRW (ROYAL/RED/WHITE)



ALPHA FR2 GLOVE



CORE TECHNOLOGY
ALPHA
HYBRID TAPER FIT

PROCUFF

PROPALM

WARTECH FNC LINER
Powered by Polygiene

DUO-LAM

HYBRID TAPER FIT | Allows the glove to contour to the natural shape of your hand, maximizing mobility and improving protection.

PRO CUFF | Extends your range of motion improving puck handling while still protecting your wrists from slashes.

BUTTERSOFTEEL | Responsive mesh gussets, a 3 piece finger, and our AXYFLEX THUMB accompanied by the anatomical stretch backhand give the LX2 Pro gloves a snappy, game ready feel right off the shelf.

DUO-LAMB | 2 layers of foam including HD VN and mid-density foams combined with plastic inserts in the backhand, cuff, and fingers that keep your hands protected.

PRO PALM | A pro tested Ax Suede palm with embossed grip

STYLE CODES | SIZES

FR2GS3 13, 14, 15 [SENIOR]
FR2GJ3 10, 11, 12 [JUNIOR]
FR2GY3* 8,9 [YOUTH] *SELECT COLORS ONLY

COLORS

BK (BLACK)*, BKO (BLACK/ORANGE), BSG (BLACK/SPORT GOLD), BKW (BLACK/WHITE), BVG (BLACK/VEGAS GOLD), **BRD (BLACK/RED)***, FG (FOREST GREEN), RL (ROYAL), NRD (NAVY/RED), NSG (NAVY SPORT GOLD), **NV (NAVY)***, **RD (RED)***, RRW (ROYAL/RED/WHITE)



COVERT CF 100 HELMET TECHNOLOGY

COVERT CF 100

CUSTOM FIT
INSERT

IMPAX
FOAM

OCCIPITAL
LOCK 6



COVERT HELMETS

COVERT HELMETS

COVERT CF 100 HELMET



▲ COMBO

CORE TECHNOLOGY

CUSTOM FIT INSERT IMPAX FOAM OCCIPITAL LOCK 6

CUSTOM FIT INSERTS | Heat moldable inserts in the front and back of the helmet allow for a custom fit for each individual player, providing the perfect fit no matter the head shape. Dialing in the perfect fit is not just about comfort, it is also Step 1 in protection. The CF 100 is the ultimate combination of fit, comfort and protection.

LINER | EPP liner is the foundation to providing lightweight protection against all impacts. IMPAX foam zones over the temples provide an additional level of protection against hits and other impacts.

SNAP FLAPS | Traditional tool-less adjustment system to properly fit the helmet, hassle free.

COOLING VENTS | Integrated within the helmet shell, our unique vent design directs air flow thru the helmet and around the player's head to help stay cool out on the ice

CF 100 HELMET

STYLE CODE | SIZES | COLORS

STYLE CODE	SIZES	COLORS
CF100H2	S, M, L	BK (BLACK) NV (NAVY) RD (RED) RL (ROYAL) WH (WHITE)



CF 100 HELMET COMBO

STYLE CODE | SIZES | COLORS

STYLE CODE	SIZES	COLORS
CF100HC2	S, M, L	BK (BLACK) NV (NAVY) RD (RED) RL (ROYAL) WH (WHITE)



▲ NV ▲ RD ▲ RL ▲ WH

COVERT CF 80 HELMET



▲ COMBO

CORE TECHNOLOGY

IMPAX FOAM OCCIPITAL LOCK 6

LINER | Multiple layers of VN foam and an Occipital lock to maximize protection and comfort.

SNAP FLAPS | Traditional tool-less adjustment system to properly fit the helmet, hassle free.

COOLING VENTS | Integrated within the helmet shell, our unique vent design directs air flow thru the helmet and around the player's head to help stay cool out on the ice.

CF 80 HELMET

STYLE CODE | SIZES | COLORS

STYLE CODE	SIZES	COLORS
CF80H3	S, M, L	BK (BLACK) NV (NAVY) RD (RED) RL (ROYAL) WH (WHITE)



CF 80 HELMET COMBO

STYLE CODE | SIZES | COLORS

STYLE CODE	SIZES	COLORS
CF80HC3	S, M, L	BK (BLACK) NV (NAVY) WH (WHITE)

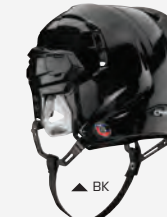

▲ NV ▲ RD ▲ RL ▲ WH

ALPHA ONE HELMET TECHNOLOGY

TRUE ONE
SHELL



ULTRA-RIGID
ONE-PIECE SHELL

OMNISHOCK+
SYSTEM

VICONIC
IMPAX
FOAM



VICONIC

EPP FOAM

IMPAX FOAM

COMFORT PADDING

adaptFIT 360 | BOA®



FULL 360 WRAP

LATERAL LACE GUIDES

DUAL-MATERIAL DIAL

ALPHA ONE HELMET



▲ COMBO

CORE TECHNOLOGY

TRUE ONE SHELL | **OMNISHOCK+ SYSTEM** | **adaptFIT 360**

TRUE ONE SHELL | A one piece high density plastic shell provides superior stiff, strong and lightweight barrier of advanced protection. Designed to provide best in class impact diffusion coupled with a profile that is aesthetically sleek.

OMNISHOCK+ PROTECTION SYSTEM W/ VICONIC INSERTS | Focused impact zones on the frontal lobe, temples and occipital are enhanced with a lightweight diffusion plate called Viconic. Viconic absorbs multiple impacts both linear and twisting. The Impax soft touch foam shield and the Viconic pods are special elements designed for specific small and large impacts. The OmniShock+ system is enhanced hockey helmet design.

ADAPTFIT 360 BY BOA | The AdaptFit 360 provides fit equalization all around your head with the micro adjustment of a BOA dial.

COLOR CUSTOMIZATION | In every box use the easy to apply side decals to customize your helmet with a splash of color.

ALPHA ONE HELMET STYLE CODE | SIZES | COLORS

A1H8	S, M, L	BK (BLACK) NV (NAVY) RD (RED) RL (ROYAL) WH (WHITE)
-------------	---------	---



ALPHA ONE HELMET COMBO STYLE CODE | SIZES | COLORS

A1HC8	S, M, L	BK (BLACK) NV (NAVY) WH (WHITE)
--------------	---------	---------------------------------------

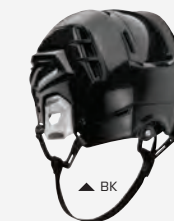

ALPHA PRO HELMET



▲ COMBO

CORE TECHNOLOGY

TRUE ONE SHELL | **OMNISHOCK SYSTEM** | **adaptFIT 270**

TRUE ONE PRO SHELL | A one piece high density plastic shell provides superior stiff, strong and lightweight barrier of advanced protection. Designed to provide best in class impact diffusion coupled with a profile that is aesthetically sleek.

OMNISHOCK PROTECTION SYSTEM W/ IMPAX FOAM | Focused impact zones on the frontal lobe, temples and occipital are enhanced with a lightweight diffusion plate called Viconic. Viconic absorbs multiple impacts both linear and twisting. The Impax soft touch foam shield and the Viconic pods are special elements designed for specific small and large impacts. The OmniShock+ system is enhanced hockey helmet design.

ADAPTFIT 270 BY BOA | The AdaptFit 270 provides fit equalization all around your head with the micro adjustment of a BOA dial.

COLOR CUSTOMIZATION | In every box use the easy to apply side decals to customize your helmet with a splash of color.

ALPHA PRO HELMET STYLE CODE | SIZES | COLORS

APH8	S, M, L	BK (BLACK) NV (NAVY) RD (RED) RL (ROYAL) WH (WHITE)
-------------	---------	---



ALPHA PRO HELMET COMBO STYLE CODE | SIZES | COLORS

APHC8	S, M, L	BK (BLACK) NV (NAVY) WH (WHITE)
--------------	---------	---------------------------------------

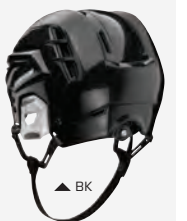

COVERT CF 100 REPLACEMENT FOAM INSERTS



CUSTOM FIT INSERTS | Heat moldable inserts in the front and back of the helmet allow for a custom fit for each individual player, providing the perfect fit no matter the head shape. Dialing in the perfect fit is not just about comfort, it is also Step 1 in protection. The CF 100 is the ultimate combination of fit, comfort and protection.



SCAN QR CODE TO VIEW HOW TO VIDEO



CF 100 HELMET REPLACEMENT FOAM INSERTS

STYLE CODE | SIZES | COLORS

CF100CFI2 S, M, L BK (BLACK)

ALPHA ONE CAGE



VISION | Optimum vision clarity keeps you focused on the game.

CHIN CUP CUSTIMAZATION | Suspended floating dual density chin cup adjusts comfortably to individual face shapes.

PROTECTION | Proven full protection comfortable shape.

COLOR | Offered in black and silver for personal style.

COMPATIBILITY | Fully compatible with all Warrior and industry helmets.

STYLE CODE | SIZES | COLORS

A1BLK8 S, M, L BK (BLACK)

STYLE CODE | SIZES | COLORS

A1SLV8 S, M, L SL (SILVER)

KROWN 2.0 CAGE



VISION | Designed for optimum vision.

PROTECTION | Proven full protection comfortable shape.

STYLE CODE | SIZES | COLORS

HHCGBLK3 S, M, L, XL BK (BLACK)

STYLE CODE | SIZES | COLORS

HHCGSLV3 S, M, L, XL SL (SILVER)

ALPHA ONE HELMET LINER

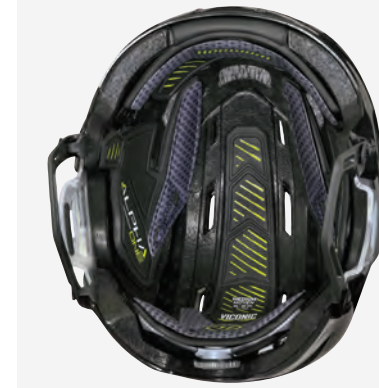

ALPHA ONE HELMET LINER:
STYLE: AOHL9
BK (BLACK)
SIZES: OSZ

ALPHA PRO HELMET LINER



ALPHA ONE PRO HELMET LINER:
STYLE: AOPHL9
BK (BLACK)
SIZES: OSZ

KROWN CHIN STRAP



KNOWN CHIN STRAP
STYLE: HHCSKRO2
COLORS:
BK (BLACK)
WH (WHITE)
SIZES: M and L

KROWN EAR LOOPS



KNOWN EAR LOOPS
STYLE: HHEKRO2
COLORS:
BGR (BLACK/GREY)
BK (BLACK)
WH (WHITE)
SIZES: M and L

ALPHA EAR COVERS



ALPHA EAR COVERS
STYLE: AEARC8
COLOR: CLEAR
SIZES: S/M, L/XL

EAR COVERS

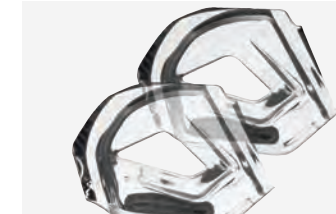

EAR COVERS
STYLE: HHECKRO2
COLOR: CLEAR
SIZES: S, M, L, XL

CHIN CUP



CHIN CUP
STYLE: HCCKRO2
COLOR: BK (Black)
SIZES: M, L

CAGE CLIP HARDWARE

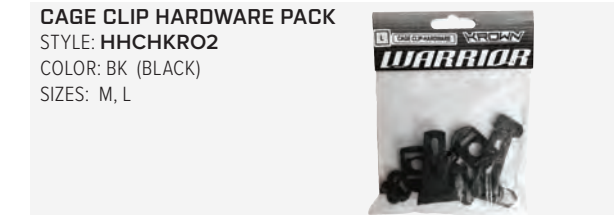

CAGE CLIP HARDWARE PACK
STYLE: HHCHKRO2
COLOR: BK (BLACK)
SIZES: M, L

HOCKEY HELMET VN FOAM

STYLE: HHVN209 (Not pictured)

HELMET SIZING CHARTS

COVERT CF 100

HAT SIZE

CM

SMALL

6 ³/₄ - 7

54 - 56

MEDIUM

7 - 7 ³/₈

56 - 59

LARGE

7 ³/₈ - 7 ³/₄

59 - 62

COVERT CF 80

HAT SIZE

CM

SMALL

6 ³/₄ - 7

54 - 56

MEDIUM

7 - 7 ³/₈

56 - 59

LARGE

7 ³/₈ - 7 ³/₄

59 - 62

ALPHA ONE

HAT SIZE

CM

SMALL

6 ¹/₂ - 7

52 - 56

MEDIUM

7 - 7 ³/₈

56 - 59

LARGE

7 ¹/₈ - 7 ³/₄

57.5 - 62

ALPHA PRO

HAT SIZE

CM

SMALL

6 ⁵/₈ - 7

52 - 56

MEDIUM

7 - 7 ³/₈

56 - 59

LARGE

7 ¹/₈ - 7 ³/₄

57.5 - 62

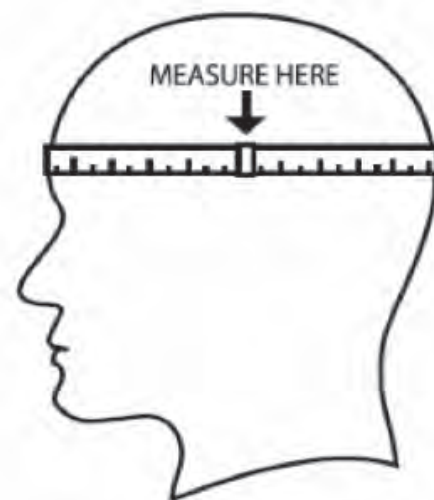

To measure your head circumference, wrap a tape measure around your head above your eyebrows and across your temples.

ADRIAN KEMPE
LOS ANGELES KINGS

HELMETS

HELMETS

ALPHA

TEAM PANTS & SHELL

ALPHA TEAM PANTS

- Alpha Taper Fit
- Adjustable Leg Extension
- Premium Protection
- Minimus Outer Shell
- Wartech FNC Liner
- Team Logo Embroidery
- Custom Striping available
- Multiple shell color options

STYLE CODES | SIZES

C-ATPSR	SENIOR
C-ATPJR	JUNIOR
C-ATPYT	YOUTH



SINGLE STRIPE



DOUBLE STRIPE



RANGER STRIPE



SINGLE STRIPE OPTIONS

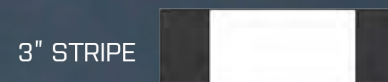
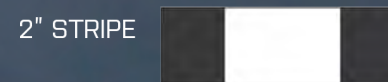
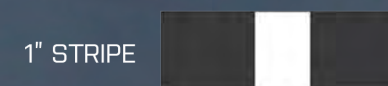

DOUBLE STRIPE OPTIONS

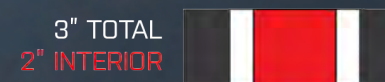

RANGER STRIPE SPECS

1" TOTAL, 1/2" INTERIOR



ALPHA TEAM SHELL

- Alpha Taper Fit
- Minimus Outer Shell
- Team Logo Embroidery
- Custom Striping available
- Multiple shell color options

STYLE CODES | SIZES

C-ATSHLS	SENIOR
C-ATSHLJ	JUNIOR

SHELL COLORS

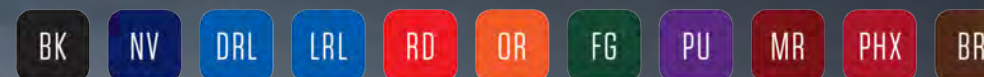

STRIPE COLORS



RITUAL GOALIE TEAM SHELL (NOT PICTURED)

- Ritual Goalie Fit
- Minimus Outer Shell
- Team Logo Embroidery
- Custom Striping available
- Multiple shell color options

STYLE CODES | SIZES

C-GSHLS3	SENIOR
C-GSHLI3	INTERMEDIATE
C-GSHLJ3	JUNIOR

ALPHA LX 20 PANTS



ALPHA PRO FIT | Tailored pro fit to follow natural skating posture. New anatomical fit thigh pad design provides maximum mobility and protection. The minimalist form fitting style allows you to remain quick and agile in game play.

ADJUSTABLE LEG EXTENSION | Fit versatility for the growing player and or the player looking for more finite adjustment. A zippered gusset allows for a 1" leg extension.

PREMIUM PROTECTION | A floating internal waist belt offers a comfort fit and holds lightweight premium protection on your hips, waist and thighs as you move throughout play. Spine and kidney pads include IMPAX foam.

MINIMUS OUTER SHELL | A mix of premium denier nylon weaves focused on lightweight, durability and mobility. Added ventilation zones and new hamstring padding adds even more breathability and protection.

LINER | Stay cool and dry during play.

STYLE CODES | SIZES | COLORS

SR: **LX20PS2** S, M, L, XL BK (BLACK), NV (NAVY)
JR: **LX20PJ2** S, M, L, XL

ALPHA GIRDLE



ALPHA PRO FIT | Tailored pro fit to follow natural skating posture. The minimalist form fitting style allows you to remain quick and agile in game play.

KIDNEY AND SPINE PROTECTION | Intergrated premium molded spine and kidney protection including IMPAX foam spine moves with you as you skate and pivot.

PREMIUM PROTECTION | A strategically placed foam and plastic protection secure to your legs and hips for hard, fast game play.

WARTECH FNC LINER | A Powered by Polygiene so you are always cool, dry and odor free - the very best equipment for staying fresh and clean.

STYLE CODES | SIZES | COLORS

SR: **ALPHAGS2** S, M, L, XL BK (BLACK)
JR: **ALPHAGJ2** S, M, L, XL

ALPHA GIRDLE SHELL



ALPHA PRO FIT | Tailored pro fit to follow natural skating posture. The minimalist form fitting style allows you to remain quick and agile in game play.

ADJUSTABLE LEG EXTENSION | Fit versatility for the growing player and or the player looking for more finite adjustment. A zippered gusset allows for a 1" leg extension.

PREMIUM INTEGRATION | The shell integrates best with girdles for a better fit and improved protection,

MINIMUS OUTER SHELL | A mix of premium denier nylon weaves focused on lightweight durability and stretch.

STYLE CODES | SIZES | COLORS

SR: **ALPHAGSS2** S, M, L, XL, 2XL BK (BLACK)
JR: **ALPHAGSJ2** S, M, L, XL

WARRIOR PANT SHELL



• Integrates best when worn with pants for team specific color needs.

STYLE CODES | SIZES

SR: **PSSR5** S, M, L, XL, 2XL
JR: **P5JR5** S, M, L, XL
JR (XS): **PSJRXS8** XS

COLORS

BK (BLACK), NV (NAVY), RD (RED), DRL (DARK ROYAL), LRL (LIGHT ROYAL), FG (FOREST GREEN), MR (MAROON)

WARRIOR PANTS SIZING CHART

PANTS

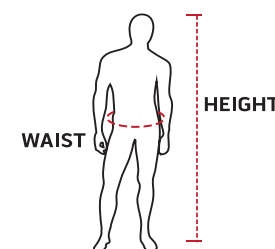

	SMALL/PETIT	MEDIUM/MOYEN	LARGE/GRAND	X-LARGE/T-GRAND
SR	H: 5'4" - 5'9" / 165CM - 180CM W: 30" - 32" / 76CM - 81CM	H: 5'6" - 6'0" / 171CM - 183CM W: 32" - 34" / 81CM - 86CM	H: 5'9" - 6'2" / 180CM - 189CM W: 34" - 36" / 86CM - 91CM	H: 6'0" + / 183CM + W: 36" - 38" / 91CM - 97CM
JR	H: 4'3" - 4'8" / 131CM - 146CM W: 22" - 24" / 56CM - 61CM	H: 4'6" - 5'1" / 140CM - 155CM W: 24" - 26" / 61CM - 66CM	H: 5'0" - 5'5" / 152CM - 168CM W: 26" - 28" / 66CM - 71CM	H: 5'4" - 5'9" / 165CM - 180CM W: 28" - 30" / 71CM - 76CM
YT	H: 3'4" - 3'7" / 104CM - 113CM W: 20" - 21" / 51CM - 53CM	H: 3'7" - 4'0" / 113CM - 122CM W: 21" - 22" / 53CM - 56CM	H: 4'0" - 4'4" / 122CM - 134CM W: 22" - 23" / 56CM - 58CM	

WARRIOR

CUSTOM STOCK PRO BAG

Visit our customizer and build your own: <http://www.warrior.com/MC-WPHB7.html>



POST EMBELLISHED

FRONT

BACK



FULL CUSTOM

FRONT

BACK

WARRIOR PRO BAG

- Pro locker room size and specifications used by pro teams
- Large durable main compartment
- Internal mesh skate pockets
- Fully customizable

STOCK STYLES / SIZES

MD (PEEWEE)	WPHPB7	(28x15x15)
LG (PLAYER)	WPHB7	(32x15x20)
XL (GOALIE)	WPHGB7	(40x20x20)
SM (COACH)	WPHCB7	(22x12x14)

POST EMBELLISHED STYLES / SIZES

MD (PEEWEE)	E-WPHPB7	(28x15x15)
LG (PLAYER)	E-WPHB7	(32x15x20)
XL (GOALIE)	E-WPHGB7	(40x20x20)
SM (COACH)	E-WPHCB7	(22x12x14)

FULL CUSTOM STYLES / SIZES

MD (PEEWEE)	C-PPB	(28x15x15)
LG (PLAYER)	C-PWB	(32x15x20)
XL (GOALIE)	C-GB	(40x20x20)
SM (COACH)	C-CB	(22x12x14)

New- CORDURA material option now available

COLORS

- BBG (BLACK/BRASS GOLD)
- BK (BLACK)
- BKO (BLACK/ORANGE)
- BRD (BLACK/RED)
- BSG (BLACK/SPORT GOLD)
- FG (FOREST GREEN)
- MR (MAROON)
- NR (NAVY/RED)
- NV (NAVY)
- RD (RED)
- RL (ROYAL)
- RRW (ROYAL/RED/WHITE)
- BGR (BLACK/GREY)



FULL CUSTOM

Visit our customizer and build your own: <http://www.warrior.com/MC-WPHB7.html>

STOCK COLORS



BAGS

BAGS

WARRIOR PRO LOCKER ROOM COOLER BAG



- Carry your favorite beverages in style.
- Classic Pro bag look.
- Thick insulation keeps inside ice cold for hours.
- Side mesh pockets
- Carry and shoulder straps make transportation a breeze.

STYLE CODES | SIZES | COLORS
WARCOOL4 17" x 9" x 7" BK (BLACK)

Q10 DAY BACKPACK



- Premium 600D polyester base
- Bright custom liner
- Padded back and straps
- Internal laptop sleeve
- Organizer inside front pocket

**POST EMBELLISHMENT
STYLE CODES | SIZES | COLORS**
E-Q10BPK4 15.5"L x 18.5"H x 6"W BK (BLACK), GR (GREY)

CUSTOM JET PACK MAX



- AFTERMARKET CUSTOMIZATION (TEAM LOGOS AND PLAYER NUMBERS).
- Know your own printer? Have us ship directly to your printer to handle your customization needs. Don't know a printer? Warrior can customize your bags with team logos and player numbers for an additional fee. One side is blank for custom logos. Contact a Warrior representative for more details.

**POST EMBELLISHMENT
STYLE CODES | SIZES | COLORS**
E-JPMB2 13"L x 22"H x 7.5"W GR (GREY)

CUSTOM JET PACK



- AFTERMARKET CUSTOMIZATION (TEAM LOGOS AND PLAYER NUMBERS).
- Know your own printer? Have us ship directly to your printer to handle your customization needs. Don't know a printer? Warrior can customize your bags with team logos and player numbers for an additional fee. One side is blank for custom logos. Contact a Warrior representative for more details.

**POST EMBELLISHMENT
STYLE CODES | SIZES | COLORS**
E-JPB1 11.5"L x 20"H x 9"W GR (GREY)

WARRIOR BALL / PUCK BAG



- Holds up to 50 hockey pucks or 75 lacrosse balls
- Heavy duty plastic base keeps bag upright
- Drainage holes in base ensure bag stays dry
- Premium 600D material with water proof zipper

STYLE CODES | SIZES | COLORS
WPBBAGO 4.7"L x 18"H x 13.5"D BK (BLACK)

Q10 DAY DUFFLE BAG



- Premium 600D polyester base
- Bright custom liner
- Luggage strap

**POST EMBELLISHMENT
STYLE CODES | SIZES | COLORS**
E-Q10DUF8 19"L x 10"H x 10"W BK (BLACK), GR (GREY)

CORE TOILETRY BAG



- Jacquard webbing grab handle
- Zipper front pocket
- Interior mesh pocket with extra organization pockets

STYLE CODES | SIZES | COLORS
CORETOI3 10"L x 8"H x 4.5"D BK (BLACK)



WOMENS APPAREL



WOMENS ALPHA X PRESENTATION JACKET



- 100% Polyester woven shell
- 100% Polyester mesh lining
- WARTECH Technology: Moisture management system keeps warmth in while letting sweat and moisture out.
- Adjustable drawcord at hem
- Zippered hand pockets
- Relaxed fit

POST EMBELLISHMENT
STYLE CODES | SIZES | COLORS
 Adult: **E-WJ9041** XS-2XL BK (BLACK)

STOCK
STYLE CODES | SIZES | COLORS
 Adult: **WWJ9041** XS-2XL BK (BLACK)

WOMENS ALPHA X PRESENTATION PANT



- 100% Polyester woven shell
- 100% Polyester mesh lining
- WARTECH Technology: Moisture management system keeps warmth in while letting sweat and moisture out.
- Zippered hand pockets
- Zippered opening at hem cuff
- Relaxed fit

POST EMBELLISHMENT
STYLE CODES | SIZES | COLORS
 Adult: **E-WP9042** S-2XL BK (BLACK)

STOCK
STYLE CODES | SIZES | COLORS
 Adult: **WWP9042** S-2XL BK (BLACK)

WOMENS ALPHA X CTF TEE



BK



GNM

- Knitted Polyester fabric
- Raglan sleeve design
- WarTech moisture wicking system to help keep body dry and comfortable
- Heat transfer Warrior logo on front chest.
- Side seam split for range of movement
- Dropped back hem for comfort and fit

**POST EMBELLISHMENT
STYLE CODES | SIZES | COLORS**

Adult: **E-WT9044** XS-2XL BK (BLACK), GNM

**STOCK
STYLE CODES | SIZES | COLORS**

Adult: **WWT9044** XS-2XL BK (BLACK)
GNM (GUNMETAL)

WOMENS ALPHA X SHORT



- Woven fabric with mesh liner
- Two zipped side pockets
- Heat transfer Warrior logo to front lower thigh
- Elasticated waistband for comfort and fit
- Internal drawcord for fit

**POST EMBELLISHMENT
STYLE CODES | SIZES | COLORS**

Adult: **E-WS9039** S-2XL BK (BLACK)

**STOCK
STYLE CODES | SIZES | COLORS**

Adult: **WWS9039** S-2XL BK (BLACK)

WOMENS COMPRESSION JILL SHORT



- 85% nylon, 15% Spandex
- Removable foam insert for ultimate protection and comfort.
- Reinforced Velcro sock tabs keep socks in place during play.
- Mesh inseam provides ventilation.
- Flat lock seams for unrestricted movement.

STYLE CODES | SIZES | COLORS

WJILLSHT3 S-L BK (BLACK)



MENS APPAREL

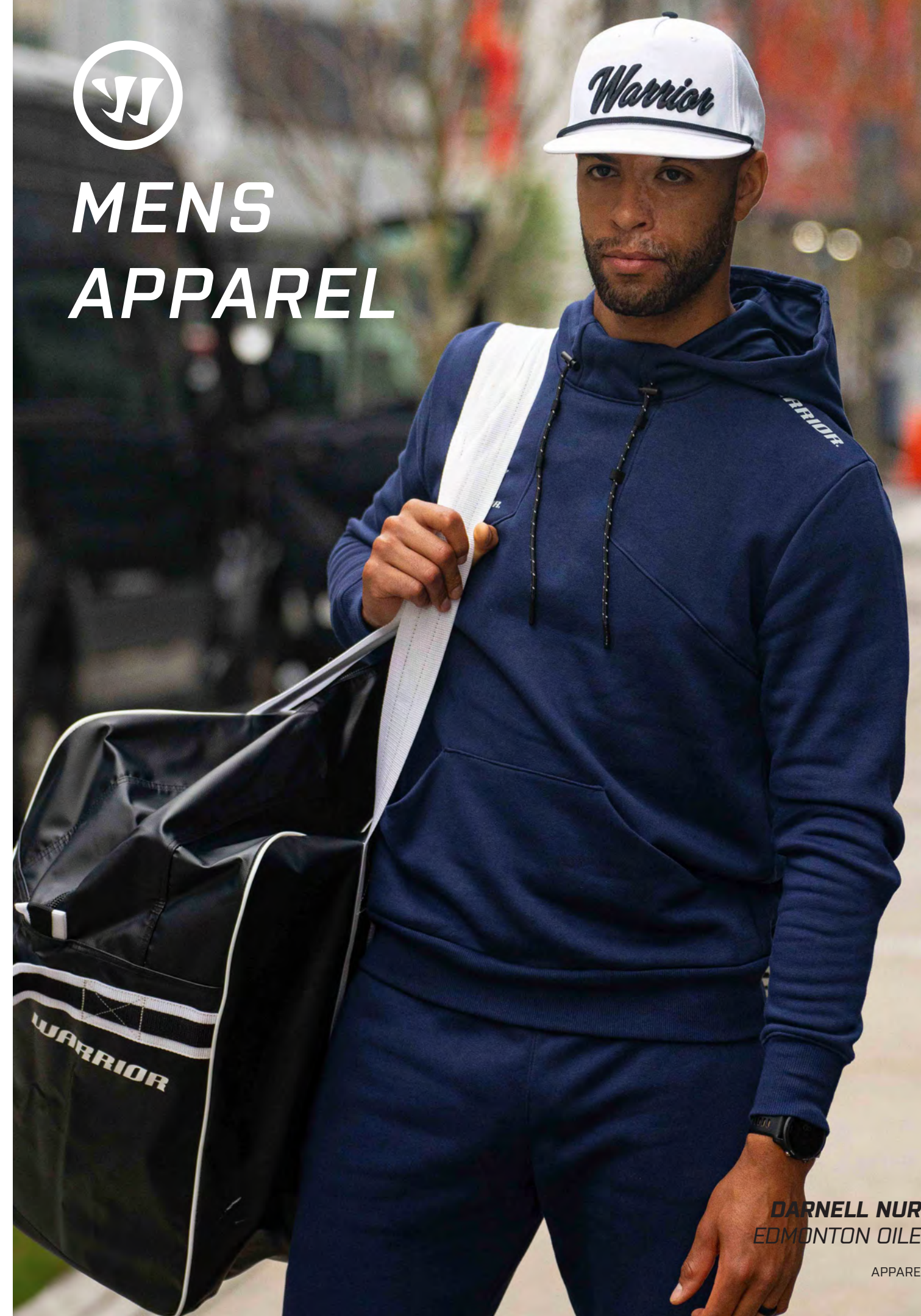

DARNELL NURSE
EDMONTON OILERS

ALPHA X PRESENTATION JACKET



- 100% Polyester woven shell
- 100% Polyester mesh lining
- WARTECH Technology: Moisture management system keeps warmth in while letting sweat and moisture out.
- Adjustable drawcord hem
- Zippered hand pockets

• Relaxed fit

POST EMBELLISHMENT

STYLE CODES	SIZES	COLORS
Adult: E-MJ9041	S - 3XL	BK (BLACK), NV (NAVY)
Youth: E-JJ9041	SB - XLB	

STOCK

STYLE CODES	SIZES	COLORS
Adult: WMJ9041	S - 3XL	BK (BLACK), NV (NAVY)
Youth: WJJ9041	SB - XLB	

ALPHA X PRESENTATION PANT



- 100% Polyester woven shell
- 100% Polyester mesh lining
- WARTECH Technology: Moisture management system keeps warmth in while letting sweat and moisture out.
- Zippered hand pockets
- Zippered opening at hew cuff

• Relaxed fit

POST EMBELLISHMENT

STYLE CODES	SIZES	COLORS
Adult: E-MP9042	S - 3XL	BK (BLACK), NV (NAVY)
Youth: E-JP9042	SB - XLB	

STOCK

STYLE CODES	SIZES	COLORS
Adult: WMJ9042	S - 3XL	BK (BLACK), NV (NAVY)
Youth: WJJ9042	SB - XLB	

ALPHA X ASPIRE HOODIE



- 70% Thermal Funtion Polyester / 30% Cotton
- High collar hoodie
- Intergrated drawcord
- Cut & sew chest panels
- Heat Transfer Logo
- Reflective Warrior logos on shoulder.

POST EMBELLISHMENT

STYLE CODES	SIZES	COLORS
Adult: E-M31163	S - 3XL	BK (BLACK), NV (NAVY), GRM (GREY MARL)
Junior: E-J31163	YXS - YXL	

STOCK

STYLE CODES	SIZES	COLORS
Adult: MT131163	S - 3XL	BK (BLACK), NV (NAVY), GRM (GREY MARL)
Junior: JT131163	YXS - YXL	

ALPHA X ASPIRE JOGGER



- Cotton Poly Tech fleece
- Drawcord waistband
- Zippered hand pockets
- Stretch cuff finish
- Shaped calf panels
- Heat Transer Logo

POST EMBELLISHMENT

STYLE CODES	SIZES	COLORS
Adult: E-M31165	S - 3XL	BK (BLACK), NV (NAVY), GRM (GREY MARL)
Junior: E-J31165	YXS - YXL	

STOCK

STYLE CODES	SIZES	COLORS
Adult: MP131165	S - 3XL	BK (BLACK), NV (NAVY), GRM (GREY MARL)
Junior: JP131165	YXS - YXL	

ALPHA X CTF TEE



- Knitted Polyester fabric
- Raglan sleeve design
- WARECH Technology: Moisture wicking system to keep you dry
- Heat transfer Warrior logo on front chest
- Side seam split for range of movement
- Dropped back hem for comfort and fit

POST EMBELLISHMENT

STYLE CODES	SIZES	COLORS
Adult: E-MT9044	S - 3XL	HRD (RED), BK (BLACK), NV (NAVY),
Junior: E-JT9044	XSB - XLB	TRY (ROYAL), GNM (GREY MARL)

STOCK

STYLE CODES	SIZES	COLORS
Adult: WMT9044	S - 3XL	HRD (RED), BK (BLACK), NV (NAVY),
Junior: WJT9044	XSB - XLB	TRY (ROYAL), GNM (GREY MARL)

ALPHA X CTF SHORT



- Woven fabric with mesh liner
- Two zipped side pockets
- Heat transfer Warrior logo on front lower thigh.
- Elasticated waistband for comfort and fit
- Internal drawcord for fit

POST EMBELLISHMENT

STYLE CODES	SIZES	COLORS
Adult: E-MS9039	S - 3XL	HRD (RED), BK (BLACK), NV (NAVY),
Junior: E-JS9039	XSB - XLB	GNM (GREY MARL)

STOCK

STYLE CODES	SIZES	COLORS
Adult: WMS9039	S - 3XL	HRD (RED), BK (BLACK), NV (NAVY),
Junior: WJS9039	XSB - XLB	GNM (GREY MARL)



NOAH HANIFIN
CALGARY FLAMES

WARRIOR BLANKO HOODIE



- 80% Cotton / 20% Polyester blend
- Warrior Woven Label
- Relaxed fit
- Choose between two template options to decorate using your team name and logo:

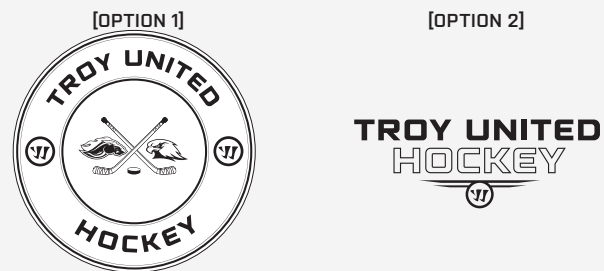

POST EMBELLISHMENT
STYLE CODES | SIZES | COLORS

Adult: **E-WMLHBL** S - 3XL BK (BLACK), NV (NAVY),
Junior: **E-WJLHBL** YXS-YXL HG (HEATHER GREY)

WARRIOR BLANKO TEE



- 100% Cotton
- Warrior Woven Label
- Relaxed fit
- Choose between two template options to decorate using your team name and logo:

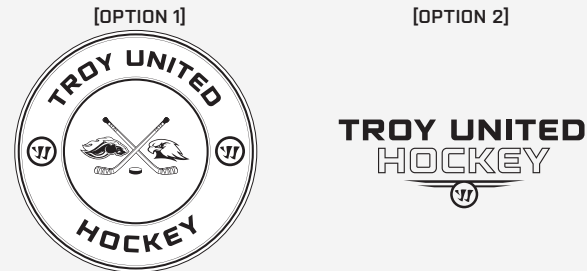

POST EMBELLISHMENT
STYLE CODES | SIZES | COLORS

Adult: **E-WBLSHR** S - 3XL BK (BLACK), NV (NAVY), WH (WHITE),
Junior: **E-WJTBL9** YXS-YXL HG (HEATHER GREY)



LUKAS REICHEL
CHICAGO BLACKHAWKS



COVERT HYBRID PULLOVER

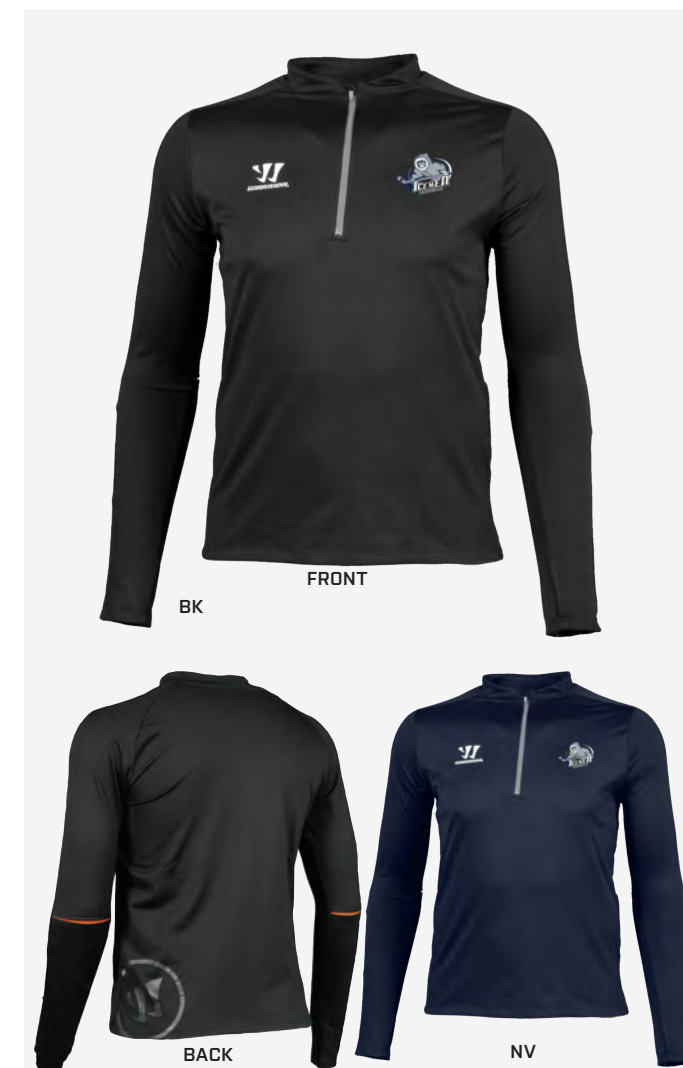

- 100% polyester knitted
- 1/4 front zip opening
- Thumbhole intergrated on cuff
- Elasticated waistband for comfort and fit
- Distinctive Warrior branding

POST EMBELLISHMENT
STYLE CODES | SIZES | COLORS

Adult: **E-M33204** S - 3XL BK (BLACK) ONLY
 Junior: **E-J33204** XSB - XLB BK (BLACK), NV (NAVY)

STOCK
STYLE CODES | SIZES | COLORS

Adult: **MT33204** S - 3XL BK (BLACK) ONLY
 Junior: **JT933204** XSB - XLB BK (BLACK), NV (NAVY)

BRAD MARCHAND
BOSTON BRUINS

APPAREL

APPAREL

WARRIOR LOOSE TECH LONG SLEEVE



- 100% Micro Poly
- Soft, cotton-like feel.
- Loose fit
- WARTECH moisture wicking system to keep your body dry and comfortable.

STYLE CODES | SIZES | COLORS

Mens: **WMLT7001** S-2XL BK (BLACK)

WARRIOR LOOSE TECH TIGHT



- 100% Micro Poly
- Loose fit
- WARTECH moisture wicking system to keep your body dry and comfortable.
- Deep waistband for comfort.

STYLE CODES | SIZES | COLORS

Mens: **WMLT7002** S-2XL BK (BLACK)

WARRIOR CHALLENGE LONG SLEEVE



- 88% Polyester, 12% Spandex
- Fitted
- Flatlock seams
- Mesh back panel

STYLE CODES | SIZES | COLORS

Mens: **WCOMPLS3** S-2XL BK (BLACK)

WARRIOR CHALLENGE SHORT SLEEVE



- 88% Polyester, 12% Spandex
- Fitted
- Flatlock seams
- Mesh back panel

STYLE CODES | SIZES | COLORS

Mens: **WCOMPSS3** S-2XL BK (BLACK)

WARRIOR COMPRESSION SHORT W/ CUP



- 80% Polyester, 20% Spandex / Compression Fit short offers stretch with comfort.
- Warrior ABS plastic sport cup with soft edges stays securely and comfortably in place.
- Bonded tape ensures a secure cup fit, while mesh pocket allows breathability.
- Low-Profile Velcro sock garters provide a secure hold.

STYLE CODES | SIZES | COLORS

Senior: **WCSHORT3** XS-2XL BK (BLACK)
 Junior: **WCSCUPJ8** S-L BK (BLACK)
 Youth: **WCSCUPY8** S/M, M/L BK (BLACK)

WARRIOR COMPRESSION TIGHT W/ CUP



- 80% Polyester, 20% Spandex / Compression Fit short offers stretch with comfort.
- Warrior ABS plastic sport cup with soft edges stays securely and comfortably in place.
- Bonded tape ensures a secure cup fit, while mesh pocket allows breathability.
- Low-Profile Velcro sock garters provide a secure hold.

STYLE CODES | SIZES | COLORS

Senior: **WCTIGHT3** XS-2XL BK (BLACK)
 Junior: **WCTGHYJ8** S-L BK (BLACK)
 Youth: **WCTGHTY8** S/M, M/L BK (BLACK)

WARRIOR LOOSE SHORT W/ CUP



- A classic relaxed fit short design offers cup support with a loose, free feel.
- WARTECH quick wick drying fabric free of sweat and odor.
- Warrior ABS plastic sport cup with soft edges stays securely and comfortably in place.
- Low-Profile Velcro sock garters provide a secure hold

STYLE CODES | SIZES | COLORS

Senior: **WHLSSHR3** XS-2XL BK (BLACK)
 Junior: **WCLSRJT8** S-L BK (BLACK)
 Youth: **WCLSRTY8** S/M, M/L BK (BLACK)

WARRIOR 3 IN 1 PARKA



- 3 in 1 Style jacket
- 100% Polyester outer shell with bonded pockets and hood peak along with waterproof 2-way zipper.
- 100% Polyester inner jacket that is removable with knit sleeves.

POST EMBELLISHMENT
STYLE CODES | SIZES | COLORS

Adult: **E-M33201** S-3XL BK (BLACK),
CTR (CASTLEROCK GREY)

STOCK
STYLE CODES | SIZES | COLORS

Adult: **MJ933201** S-3XL BK (BLACK),
CTR (CASTLEROCK GREY)

WARRIOR CORPO STACK PULLOVER



- Ultra-soft French terry fabric with a Warrior corporate signature logo holds warmth, while the ribbed hem and cuffs refine the relaxed look. A kanga front pocket stores your phone or wallet during quick errand runs.
- 60% Cotton, 40% Polyester
- Woven label at left side pocket.

STYLE CODES | SIZES | COLORS

Senior: **MT81792** S-2XL BK (BLACK),
HC (HEATHER CHARCOAL)

WARRIOR STREET HOCKEY PULLOVER HOODIE



- Cut from French terry, this comfortable and casual lounge companion is ideal for getting things done - or doing nothing at all. An iconic Warrior logo design and front kanga pocket keep things classic.

- 60% Cotton, 40% Polyester

- Woven label at left side pocket.

STYLE CODES | SIZES | COLORS

Senior: **MT81794** S-2XL BK (BLACK),
HC (HEATHER CHARCOAL)

WARRIOR STREET HOCKEY ZIP HOODIE



- Cut from French terry, this comfortable and casual lounge companion is ideal for getting things done - or doing nothing at all. An iconic Warrior logo design and front kanga pocket keep things classic..

- 60% Cotton, 40% Polyester

- Woven label at left side pocket.

STYLE CODES | SIZES | COLORS

Senior: **MT81795** S-2XL BK (BLACK),
HC (HEATHER CHARCOAL)

ALPHA X POLO



NV



BK

- 100% knitted Polyester material
- Raglan sleeve design
- Printed Warrior logo on chest
- Neck includes elastic breathable mesh
- Split side seams for more freedom of movement
- Ribbed collar and cuffs

POST EMBELLISHMENT
STYLE CODES | SIZES | COLORS

Mens: **E-MT9043** S-3XL NV (NAVY),
BK (BLACK)

STOCK
STYLE CODES | SIZES | COLORS

Mens: **WMT9043** S-3XL NV (NAVY),
BK (BLACK)

WARRIOR CORPO STACK TEE



- This essential men's tee features ultra-soft fabric and a Warrior corporate signature logo.

- 60% Cotton, 40% Polyester

- Athletic fit

STYLE CODES | SIZES | COLORS

Mens: **MT81791** S-2XL BK (BLACK),
WH (WHITE)

WARRIOR STREET HOCKEY TEE



- This essential men's tee features ultra-soft fabric and a Warrior logo design.

- 60% Cotton, 40% Polyester

- Athletic fit

STYLE CODES | SIZES | COLORS

Mens: **MT81793** S-2XL BK (BLACK),
WH (WHITE)

WOMEN'S APPAREL SIZING CHART

	SIZE	CHEST (IN)	CHEST (CM)	WAIST (IN)	WAIST (CM)	INSEAM
SENIOR	S	35-37	89-94	30 - 32	76 - 81	30
	M	38-40	97-102	32 - 34	81 - 86	32
	L	41-43	104-109	34 - 36	86 - 91	34
	XL	44-47	112-120	36 - 38	91 - 96	34
	2XL	48-51	122-130	38 - 40	96 - 101	34
	3XL	52-55	132-140	40 - 42	101 - 106	34

MEN'S APPAREL SIZING CHART

	SIZE	CHEST (IN)	CHEST (CM)	WAIST (IN)	WAIST (CM)	INSEAM
SENIOR	S	35-37	89-94	30-32	76 - 81	30
	M	38-40	97-102	32-34	81 - 86	32
	L	41-43	104-109	34-36	86 - 91	34
	XL	44-47	112-120	36-38	91 - 96	34
	2XL	48-51	122-130	38-40	96 - 101	34
	3XL	52-55	132-140	40-42	101 - 106	34
JUNIOR	S	31-33	79-84	22-23	56-58	18.5
	M	34-36	86-91	24-25	61-64	19
	L	37-39	94-99	26-27	66-69	19.5
YOUTH	S/M	25-27	64-69	18-19	46-48	16.5
	M/L	28-30	71-76	20-21	51-53	17
	XSB	25	63.5	21.75	55	17.5
	SB	26-27	66-69	21-22	53-56	18
	MB	28-29	71-74	22-24	56-61	18.5
	LB	30-31	76-79	24-26	61-66	19
	XLB	32-33	81-84	26-28	66-71	19.5

LEON DRAISAITL
EDMONTON OILERS



HEADWEAR

WARRIOR TEAM TOQUE



- Double Layer Knit
- Fold up with classic fit
- Jacquard Warrior logo
- 100% Acrylic

POST EMBELLISHMENT (ON BACK OF HAT)
STYLE CODES | SIZES | COLORS

E-TTOQUE4 OSZ BK (BLACK), RD (RED), BL (BLUE), DGN (DARK GREEN)

STYLE CODES | SIZES | COLORS

TTOQUE4 OSZ BK (BLACK), RD (RED), BL (BLUE), DGN (DARK GREEN)

WARRIOR KNIT BEANIE



- Soft woven feel
- Woven label
- 100% Acrylic

POST EMBELLISHMENT (ON BACK OF HAT)
STYLE CODES | SIZES | COLORS

E-BEANIE4 OSZ BR (BROWN), CRM (CREAM), DT (DARK TEAL), DGN (DARK GREEN), BK (BLACK)

STYLE CODES | SIZES | COLORS

BEANIE4 OSZ BR (BROWN), CRM (CREAM), DT (DARK TEAL), DGN (DARK GREEN), BK (BLACK)

WARRIOR CORPO FLEX CAP



- 6 panel flex cap
- Lightweight material

STYLE CODES | SIZES | COLORS

CAPFC3 S-3XL GR (GREY), SGO (SPORT GOLD)

WARRIOR EXPLODED FELX CAP



- 6 panel classic style cap
- Lower profile crown
- Shorter curved bill
- Exploded Warrior logo

STYLE CODES | SIZES | COLORS

CAEXPSB3 OSZ BK (BLACK), DGN (DARK GREEN), NV (NAVY)

CLASSIC TOQUE



- Double layer knit
- Fold up with classic fit
- Jacquard Warrior logo
- 100% Acrylic

STYLE CODES | SIZES | COLORS

WCT2020 OSZ NG (NAVY/GOLD), BKN (BLACK/NAT), BRD (BLACK/RED)

WARRIOR PERFORATED SNAP BACK CAP



- 6 panel snapback
- Laser perforated back
- Lightweight, performance material

STYLE CODES | SIZES | COLORS

CAPPRFSB3 OSZ DMO (DARK MOSS), LTB (LIGHT BLUE)

WARRIOR PRO SNAP BACK CAP



- As seen on the pros.
- 6 panel snap back
- Light weight performance material

STYLE CODES | SIZES | COLORS

CAPPROSB3 OSZ GR (GREY)

WARRIOR SCRIPT ROPE HAT



- 5 panel snap back hat
- Puff embroidery script logo
- Rope accent

STYLE CODES | SIZES | COLORS

STYLE CODES	SIZES	COLORS
CAPROPSB3	OSZ	BRB (BRIGHT BLUE), WH (WHITE), SM (SALMON)

WARRIOR CITY SNAP BACK HAT



- 6 panel snap back design
- Warrior X City logo

STYLE CODES | SIZES | COLORS

STYLE CODES	SIZES	COLORS
CAPDETSB3	OSZ	DET (DETROIT)

STREET HOCKEY SNAP BACK HAT



- Flat brim construction
- 100% cotton twill
- Snap back closure for one size fit adjustment
- Puff embroidery

STYLE CODES | SIZES | COLORS

STYLE CODES	SIZES	COLORS
WHSB18	OSZ	BK (BLACK), BG (BURGANDY)

TEAM PERFORMANCE SNAP BACK HAT



- 6 panel classic style cap
- Full curved visor: Ready to wear, no "break - in" needed.
- Lightweight performance fabric
- Blank front ideal for post embellishment team logo.

POST EMBELLISHMENT

STYLE CODES | SIZES | COLORS

E-WTPSBO	OSZ	BK (BLACK), NV (NAVY)
----------	-----	-----------------------

STOCK

STYLE CODES | SIZES | COLORS

WTPSBO	OSZ	BK (BLACK), NV (NAVY)
--------	-----	-----------------------

WARRIOR CORPO CAP



- 6 panel classic style cap
- Full curved visor: Ready to wear, no "break - in" needed.
- Stretch-Fit: Closed back style with patented stretch sweatband providing ideal fit and comfort.

STYLE CODES | SIZES | COLORS

WCC2018	S/M, L/XL	BK (BLACK), BKH (BLACK/HEATHER CHARCOAL)
---------	-----------	--

BUCKET HAT



- Bucket style hat
- Removable chin strap

POST EMBELLISHMENT

STYLE CODES | SIZES | COLORS

E-BUCKET3	OSZ	WH (WHITE)
-----------	-----	------------

STOCK

STYLE CODES | SIZES | COLORS

BUCKET3	OSZ	WH (WHITE)
---------	-----	------------

CUT RESISTANT PRO SOCKS



- ANSI cut level 3: Save yourself from stitches.
- Padded zones in the ankles stabilize fit and increase comfort ideal for on ice and dry land training.
- Long lasting, machine washable.

STYLE CODES | SIZES | COLORS
HSCPRF9 S (4-7), M (7-10), L (10-13), XL (12-15) BK (BLACK)

PRO SKATE SOCKS



- Thin, cool and lightweight performance skate sock.
- Ankle and arch support create a stable close to the foot fit.
- Long lasting, machine washable.

STYLE CODES | SIZES | COLORS
HSSKT9 S (4-7), M (7-10), L (10-13), XL (12-15) BK (BLACK)

CUT RESISTANT SLASH GUARD



- Dual density removable padded foam protects from slashes and bumps.
 - ANSI level 3 - saves you from stitches.
 - Machine washable
- STYLE CODES | SIZES**
CRSLAGD1 OSZ
- COLORS** BK (BLACK)

ALPHA X JOCK



- Classic style jock with maximum coverage.
- Hard shell cup with soft comfort liner.
- Wide waistband holds in place during play.

STYLE CODES | SIZES | COLORS
ALPHAJOC2 S/M, L/XL BK (BLACK)

ALPHA X JOCK COMBO



- Classic style jock with maximum coverage.
- Hard shell cup with soft comfort liner.
- Wide waistband holds in place during play.
- Intergrated garter straps.

STYLE CODES | SIZES | COLORS
ALPHJOCS2 S/M, L/XL BK (BLACK)

ALPHA JOCK & COMBO SIZING CHART

SIZE	WAIST (IN)	WAIST (CM)
L / XL	35 - 40	87 - 101
S / M	30 - 34	76 - 86

1000ML WATER BOTTLE



- Push pull top for quick hydration
- Screw top for easy refilling
- Long lasting, durable plastic

STYLE CODES | SIZES | COLORS
WW1000B9 32oz BK (BLACK)
WDB100 (With long nozzle)

750ML WATER BOTTLE



- Push pull top for quick hydration
- Screw top for easy refilling
- Long lasting, durable plastic
- Finger grip

STYLE CODES | SIZES | COLORS
WW750B9 25oz BK (BLACK)

COACHES CLIP BOARD

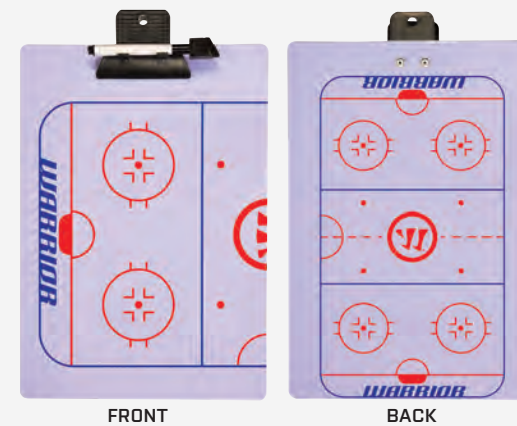

- Game strategy dry erase board: Front - Red line to the boards; Back: Full length ice
- Marker with eraser included
- Clip to hold papers

STYLE CODES | SIZES | COLORS
WHCCB9 OSZ WH (WHITE)

GOAL NET WATER BOTTLE HOLDER



- Keep your water bottle secure in goal.
- Longer velcro straps attach to the back post for quick hydration after making that epic save.

STYLE CODES | SIZES | COLORS
WGWBH9 OSZ BK (BLACK)



GOALIE

64	CUSTOM
70	LEG PADS
72	TRAPPERS
75	BLOCKERS
78	CHEST & ARMS
82	PANTS
84	JOCKS
84	COLLARS
85	KNEE PADS
86	ACCESSORIES
88	SIZING
90	STICKS
96	MASKS



R\G7 RTL

WARRIOR

R\G7 LEG PAD CUSTOMIZATION OPTIONS

LEG PAD CUSTOMIZATION

LEG PAD SIZE

SENIOR

INTERMEDIATE

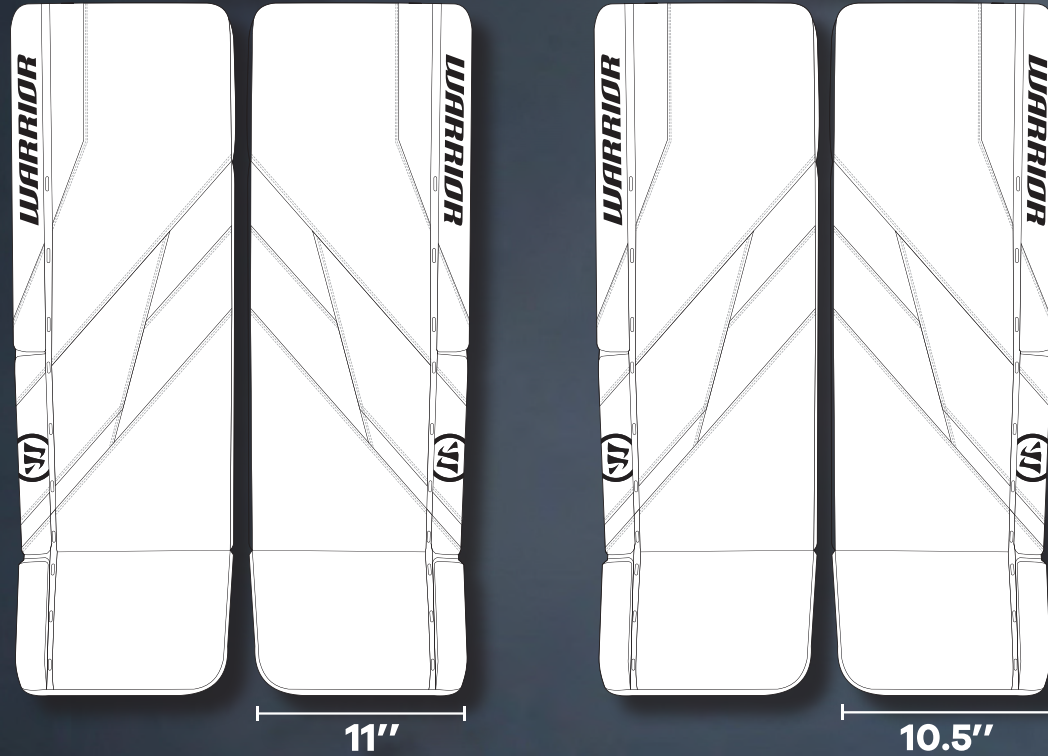

OUTER ROLL BREAK

THIGH RISE STIFFNESS

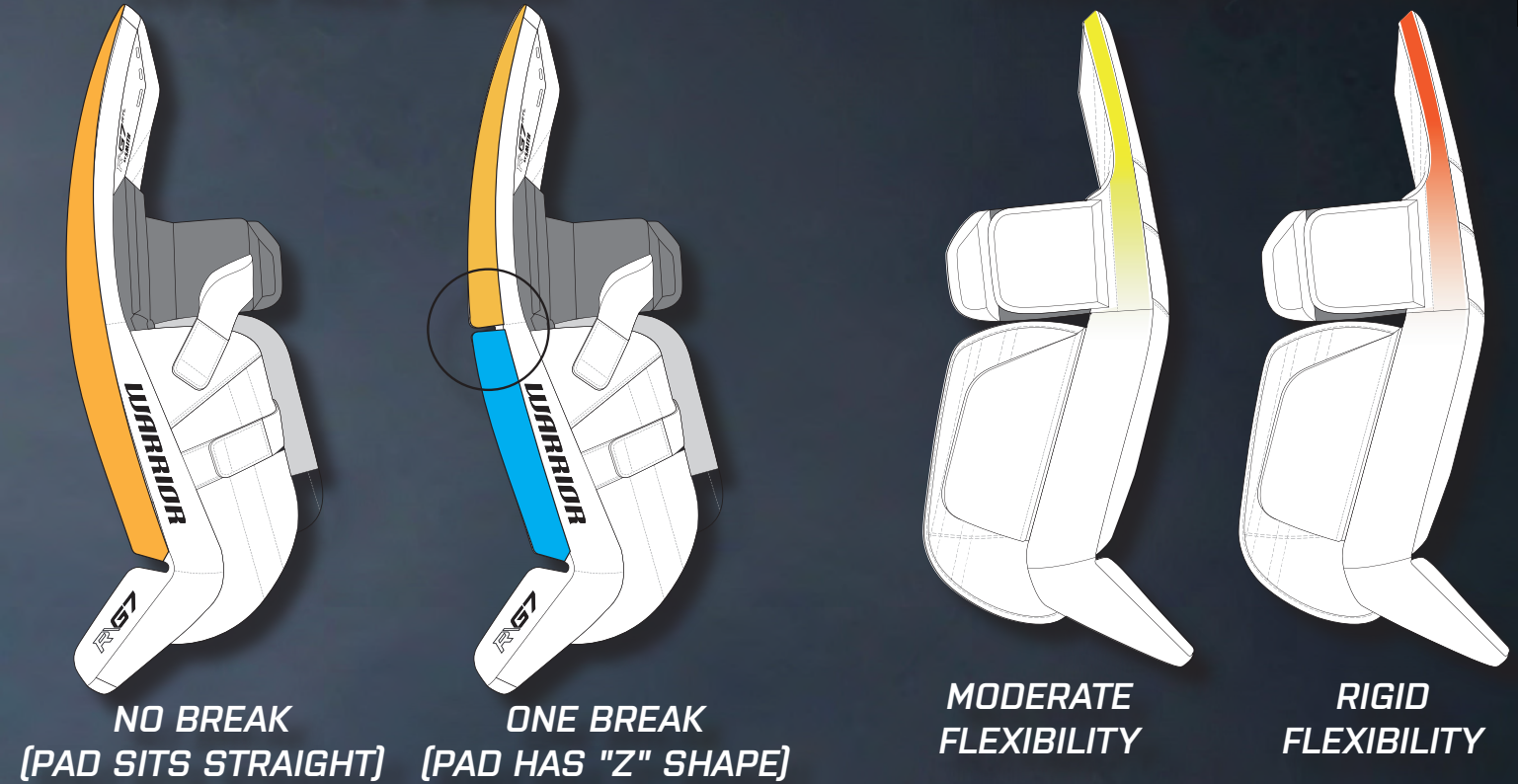

BELOW KNEE STIFFNESS

BOOT FLEX STIFFNESS

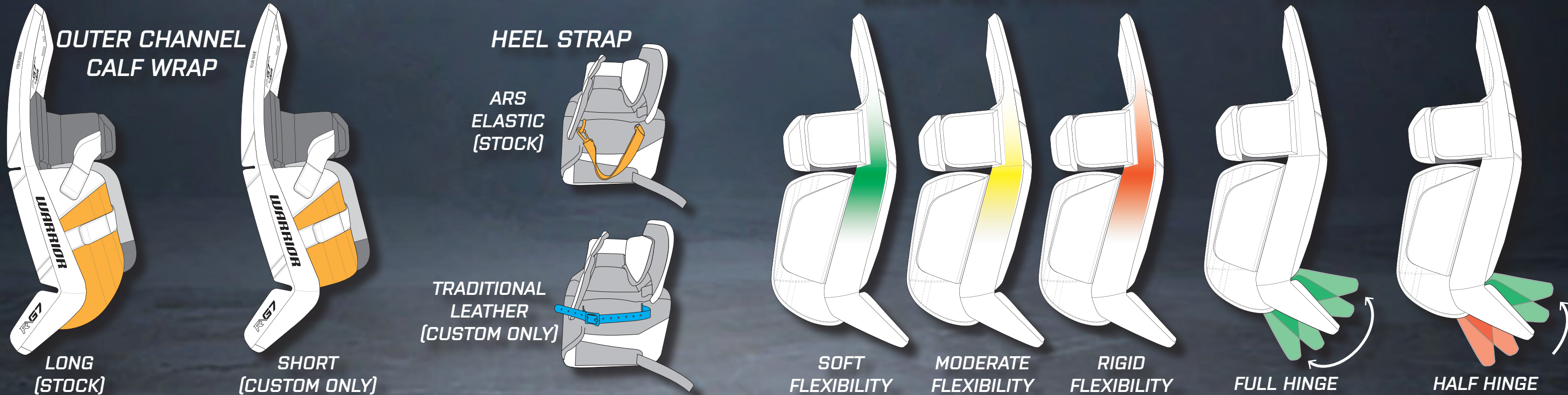

OUTER CHANNEL CALF WRAP

HEEL STRAP

ARS ELASTIC (STOCK)

TRADITIONAL LEATHER (CUSTOM ONLY)

LONG (STOCK)

SHORT (CUSTOM ONLY)



R\G7^{RTL}

CUSTOM

STOCK



CLASSIC



R\G7 RTL STOCK CUSTOM LEG PADS



- HyperComp reinforced Knee Drive System
- Stabilizing leg channel wedge
- Redesigned outer calf wrap
- SlidePlate & HD foam inner gusset
- CoverEDGE+ design
- Doubled elastic knee & calf strapping
- SlingWrap top calf strap
- Contoured shin cradle
- HyperComp reinforced thigh rise
- Adjustable knee cradle
- Adjustable ARS toe & heel straps
- Removable toe box
- G7 graphics
- Optional: Core stiffness options

STYLE CODES |

SIZES

C-G7LP4 (G7 GRAPHIC)

SR, INT

R\G7 RTL CLASSIC CUSTOM LEG PADS



- HyperComp reinforced Knee Drive System
- Stabilizing leg channel wedge
- Redesigned outer calf wrap
- SlidePlate & HD foam inner gusset
- CoverEDGE+ design
- Doubled elastic knee & calf strapping
- SlingWrap top calf strap
- Contoured shin cradle
- HyperComp reinforced thigh rise
- Adjustable knee cradle
- Adjustable ARS toe & heel straps
- Removable toe box
- G7 Classic graphics
- Optional: Core stiffness options

STYLE CODES |

SIZES

C-G7CLP4 (CLASSIC GRAPHIC)

SR

R\G7 RTL

TRAPPER CUSTOMIZATION OPTIONS

WARRIOR

R\G7 BLOCKER CUSTOMIZATION OPTIONS

BLOCKER SIZE

SENIOR

INTERMEDIATE



R\G7

MODEL

R\G7.1

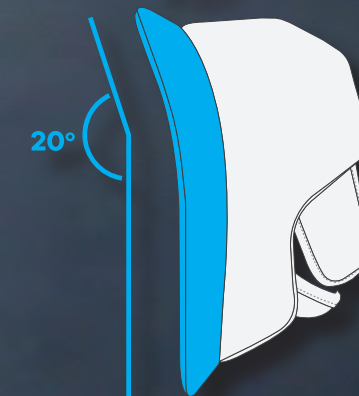

THICKER & FLATTER BOARD SHAPE



THINNER & MORE CURVED BOARD SHAPE

PALM SIZING CHART

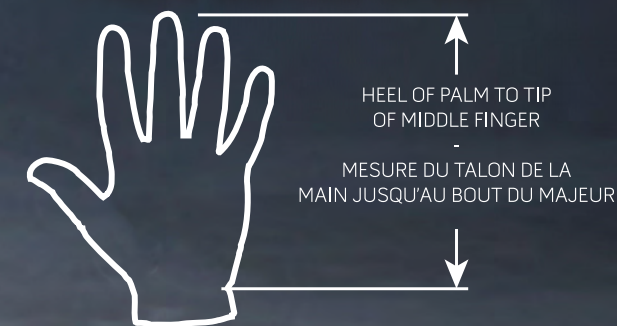

Fit: Refer to sizing guide for appropriate size selection and only deviate from it to optimize both retention and comfort on the body.

	SR MED	SR LRG	SR XL	INT.
HAND SIZE (IN)	7" - 7.5"	7.5" - 8"	8" - 8.5"	6.35" - 7"
MESURE MAIN (mm)	179 - 190	190 - 203	203 - 216	161 - 178

TRAPPER SIZE

SENIOR

INTERMEDIATE

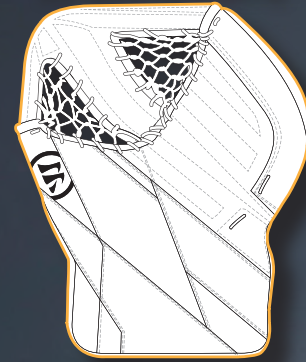
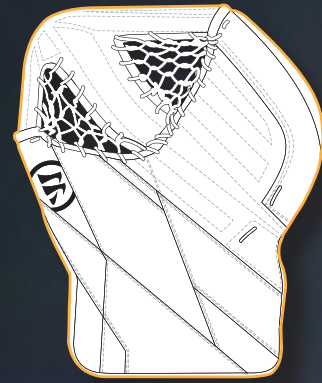

8"

7.5"

45" GLOVE (OUTER PERIMETER)

42" GLOVE (OUTER PERIMETER)

MODEL

R\G7

R\G7.1

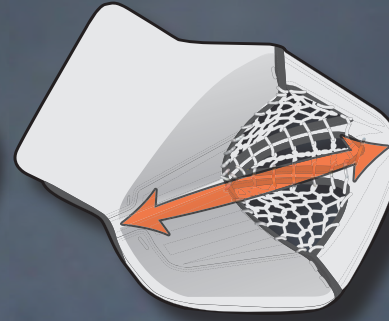
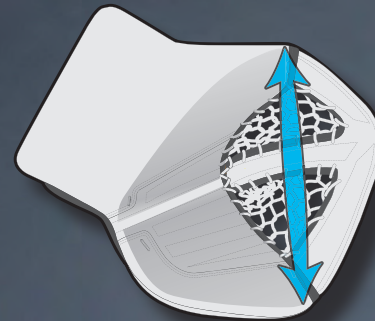

WIDER CATCHING SHAPE

LONGER CATCHING SHAPE

CORE BUILD

REGULAR

PRACTICE

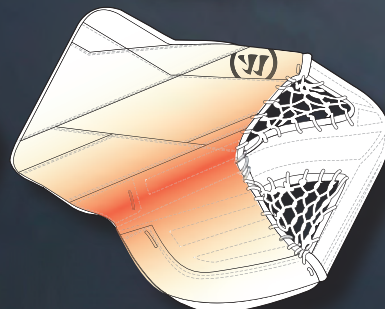
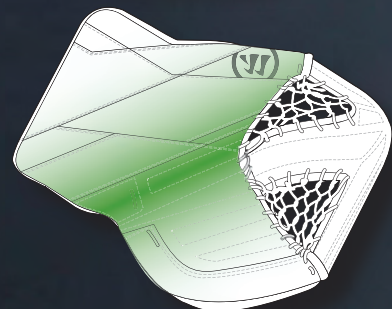

GAME-READY FEEL (STOCK)

INCREASED PROTECTION THICKER/STIFFER FEEL

LINER

60 DEGREE

75 DEGREE

90 DEGREE

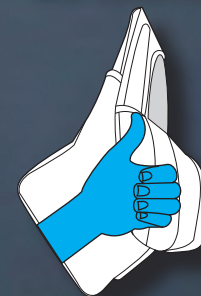
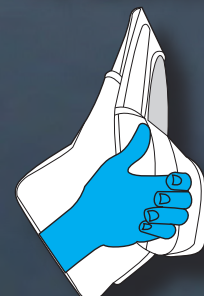
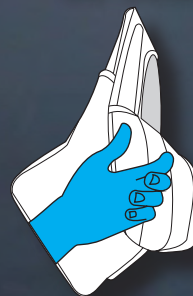

FINGER TO UPPER THUMB CLOSURE

TRADITIONAL CLOSURE

FINGER TO PALM CLOSURE

POCKET TEE

SINGLE TEE

DOUBLE TEE

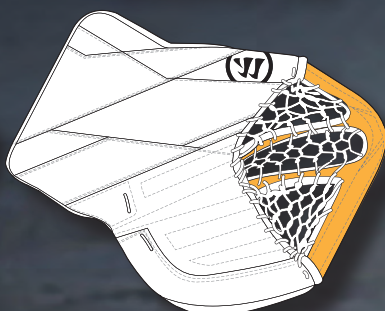
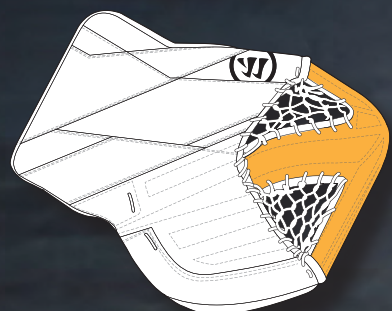

ADD-ON WRIST STRAP

NO ADD-ON

WITH ADD-ON

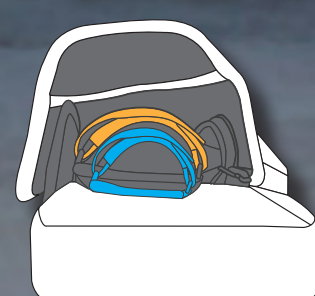

ALL STYLES AVIALBLE IN REGULAR AND FULL RIGHT HAND

R\G7 RTL CUSTOM TRAPPER



- Dimensions extend at the thumb to enhance a wider catching shape
- Index to mid-thumb closure
- Removable liner in 60, 75 or 90 degree finger positioning
- Enhanced wrist mobility
- HyperComp reinforced core increases protection
- AxyFlex Tee
- CoverEDGE+ design
- Super lightweight design with highest quality materials
- Optional: G7 and G7 Classic graphics
- Optional: Practice palm insert included
- Optional: Practice core
- G7 graphics
- Optional: Single or double tee pocket

STYLE CODES | SIZES

C-G7T4 (G7 GRAPHIC)
C-G7CT4 (CLASSIC GRAPHIC) SR, INT

R\G7.1 RTL CUSTOM TRAPPER



- Dimensions extend at the fingers to enhance a longer catching shape
- Index to low-thumb closure
- 60, 75 or 90 degree sewn in finger positioning
- Enhanced wrist mobility
- HyperComp reinforced core increases protection
- AxyFlex Tee
- CoverEDGE+ design
- Super lightweight design with highest quality materials
- Optional: G7 and G7 Classic graphics
- Optional: Practice palm insert included
- Optional: Practice core
- G7.1 Classic graphics
- Optional: Single or double tee pocket

STYLE CODES | SIZES

C-G71T4 (G7 GRAPHIC)
C-G71CT4 (CLASSIC GRAPHIC) SR

R\G7 RTL CUSTOM BLOCKER



- 20 degree board shape improves rebound speed
- Enhanced wrist mobility
- Finger guard design allows full range of motion
- X-Foam index finger protection
- HyperComp reinforced construction
- Adjustable side index finger protection
- CoverEDGE+ design
- Super lightweight design with highest quality materials
- Removable and adjustable palm
- Adjustable knee cradle
- Adjustable contoured thumb and finger protection
- G7 graphics
- Optional: INT, Medium, Large and XL palm sizes

STYLE CODES | SIZES

C-G7B4 (G7 GRAPHIC)
C-G7CB4 (CLASSIC GRAPHIC) SR, INT

R\G7 G7.1 RTL CUSTOM BLOCKER



- 35 degree board shape provides more rebound control
- Enhanced wrist mobility
- Finger guard design allows full range of motion
- X-Foam index finger protection
- HyperComp reinforced construction
- Adjustable side index finger protection
- CoverEDGE+ design
- Super lightweight design with highest quality materials
- Non-removable palm
- Adjustable knee cradle
- Adjustable contoured thumb and finger protection
- G7.1 Classic graphics
- Optional: INT, Medium, Large and XL palm sizes

STYLE CODES | SIZES

C-G71B4 (G7 GRAPHIC)
C-G71CB4 (CLASSIC GRAPHIC) SR

R\G7 RTL



R\G7 RTL SR. LEG PADS



- 1 Piece Core: Stiff Thigh & Medium Below Knee
- Single external break
- HyperComp reinforced Knee Drive System
- Stabilizing leg channel wedge
- Redesigned outer calf wrap
- HyperComp reinforced thigh rise
- SlidePlate & HD foam inner gusset
- CoverEDGE+ design
- Doubled elastic knee & calf strapping
- SlingWrap top calf strap
- Adjustable knee cradle and contoured shin cradde
- Adjustable ARS toe & heel straps and comes with a removable toe box.

STYLE CODES | COLORS | SIZES

BOOKING ONLY	◁	G7RLP4 WWW (WHITE/WHITE/WHITE)	32 + 1.5" (11" Width)
		WBK (WHITE/BLACK)	33 + 1.5" (11" Width)
		BBB (BLACK/BLACK/BLACK)	34 + 1.5" (11" Width)
		WRD (WHITE/RED)	35 + 1.5" (11" Width)
		WBR (WHITE/BLACK/RED)	36 + 1.5" (11" Width)
		WRL (WHITE/ROYAL)	

R\G7 PRO SR. / INT. LEG PADS



- 1 Piece Core: Stiff Thigh & Medium Below Knee
- Single external break
- HyperComp reinforced Knee Drive System
- Stabilizing leg channel wedge
- Redesigned outer calf wrap
- HyperComp reinforced thigh rise
- SlidePlate & HD foam inner gusset
- CoverEDGE+ design
- Doubled elastic knee & calf strapping
- SlingWrap top calf strap
- Adjustable knee cradle and contoured shin cradde
- Adjustable ARS toe & heel straps and comes with a removable toe box.

STYLE CODES | COLORS | SIZES

BOOKING ONLY	◁	SR G7PLPS4 WWW (WHITE/WHITE/WHITE)	32 + 1.5" (11" Width)	SR
		INT G7PLPI4 WBK (WHITE/BLACK)	33 + 1.5" (11" Width)	
		BBB (BLACK/BLACK/BLACK)	34 + 1.5" (11" Width)	
		WRD (WHITE/RED)	35 + 1.5" (11" Width)	
		WBR (WHITE/BLACK/RED)	36 + 1.5" (11" Width)	
		WRL (WHITE/ROYAL)	30 + 1" (10.5" Width) INT	
		31 + 1" (10.5" Width)		
		32 + 1" (10.5" Width)		

TRAPPER COMPARISON

R\G7^{RTL}

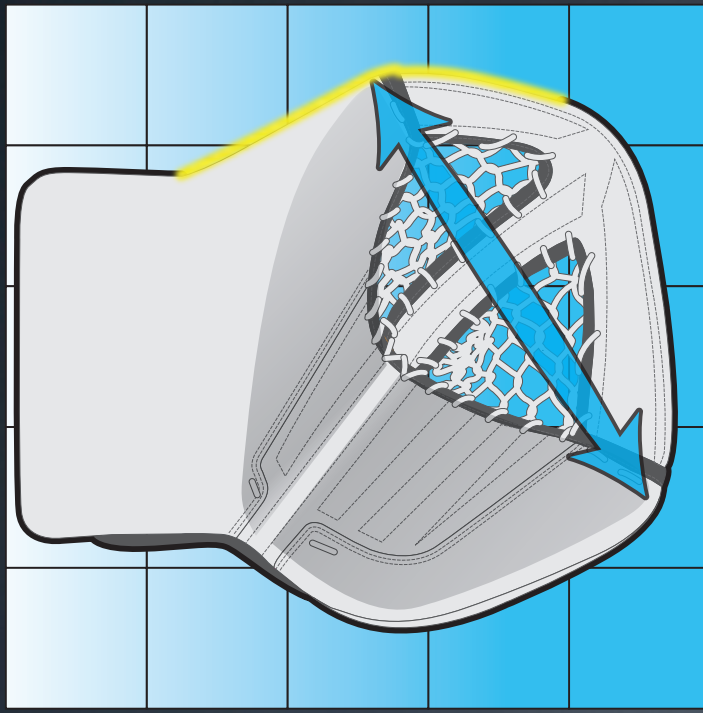

Dimensions extend at thumb to enhance a wider catching shape

R\G7.1^{RTL}

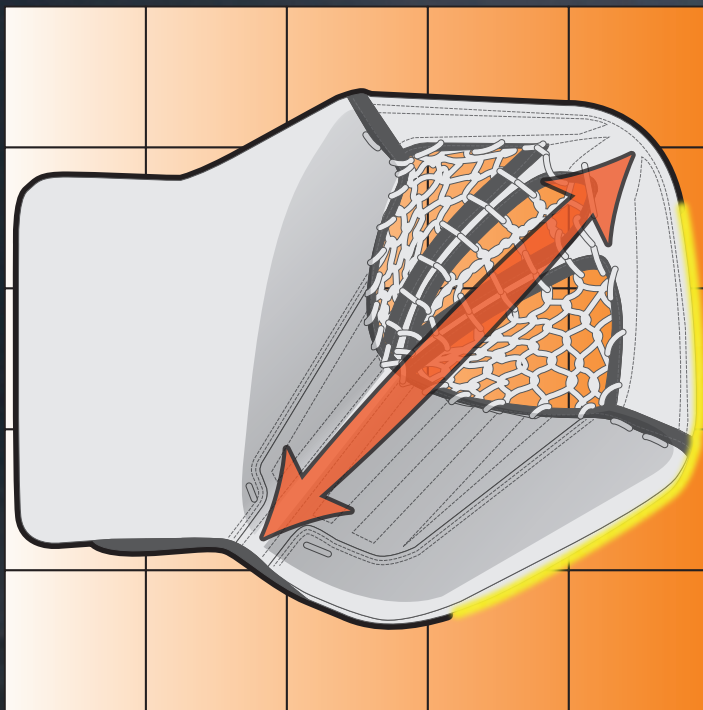

Dimensions extend at fingers to enhance a longer catching shape

RITUAL TRAPPERS

RITUAL TRAPPERS

R\G7 RTL SR. TRAPPER



- Dimensions extend at the thumb to enhance a wider catching shape
- Index to mid-thumb closure
- New cuff design enhances wrist mobility
- Removable liner in 75 degree finger positioning
- HyperComp reinforced core
- Single Tee pocket with AxyFlex Tee
- CoverEDGE+ Design

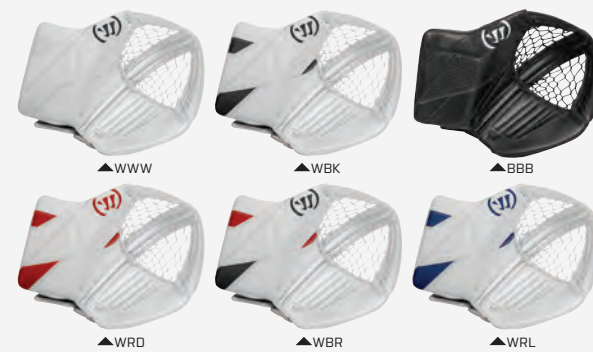

STYLE CODES | COLORS | SIZES

G7RT4	WWW (WHITE/WHITE/WHITE)	SR
G7RTF4	WBK (WHITE/BLACK)	
	BBB (BLACK/BLACK/BLACK)	
	WRD (WHITE/RED)	
	WBR (WHITE/BLACK/RED)	
	WRL (WHITE/ROYAL)	

BOOKING ONLY

REMOVABLE TRAPPER LINER INCLUDED

R\G7.1 RTL SR. TRAPPER



- Dimensions extend at the fingers to enhance a longer catching shape
- Index to low-thumb closure and new cuff design enhances wrist mobility
- New cuff design enhances wrist mobility
- 75 degree sewn in finger positioning
- HyperComp reinforced core
- Double Tee pocket with AxyFlex Tee
- CoverEDGE+ Design



STYLE CODES | COLORS | SIZES

G71RT4	WWW (WHITE/WHITE/WHITE)	SR
G71RTF4	WBK (WHITE/BLACK)	
	BBB (BLACK/BLACK/BLACK)	
	WRD (WHITE/RED)	
	WBR (WHITE/BLACK/RED)	
	WRL (WHITE/ROYAL)	

BOOKING ONLY

R\G7 PRO SR. / INT. TRAPPER



- Dimensions extend at the thumb to enhance a wider catching shape
- Index to mid-thumb closure
- New cuff design enhances wrist mobility
- Removable liner in 75 degree finger positioning
- CoverEDGE+ design
- HyperComp reinforced core
- Single Tee pocket with AxyFlex Tee



STYLE CODES | COLORS | SIZES

- SR **G7PTS4** WWW (WHITE/WHITE/WHITE) SR, INT
- SR **G7PTSF4** WBK (WHITE/BLACK)
- INT **G7PTI4** BBB (BLACK/BLACK/BLACK)
- INT **G7PTIF4** WRD (WHITE/RED)
- BOOKING ONLY WBR (WHITE/BLACK/RED)
- WRL (WHITE/ROYAL)



R\G7.1 PRO SR. TRAPPER



- Dimensions extend at the fingers to enhance a longer catching shape
- Index to low-thumb closure and new cuff design enhances wrist mobility
- New cuff design enhances wrist mobility
- 75 degree sewn in finger positioning
- CoverEDGE+ design
- HyperComp reinforced core
- Double Tee pocket with AxyFlex Tee

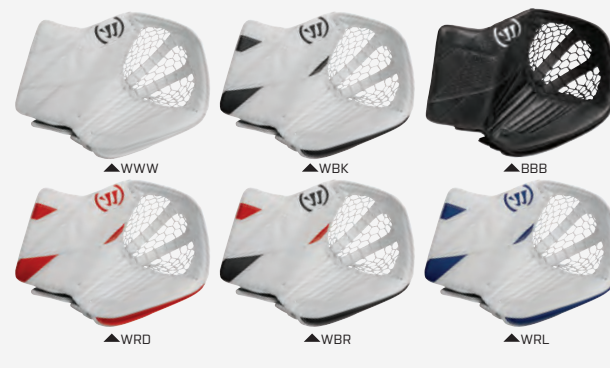

STYLE CODES | COLORS | SIZES

- G71PTS4** WWW (WHITE/WHITE/WHITE) SR (ONLY)
- G71PTSF4** WBK (WHITE/BLACK)
- BBB (BLACK/BLACK/BLACK)
- WRD (WHITE/RED)
- BOOKING ONLY WBR (WHITE/BLACK/RED)
- WRL (WHITE/ROYAL)

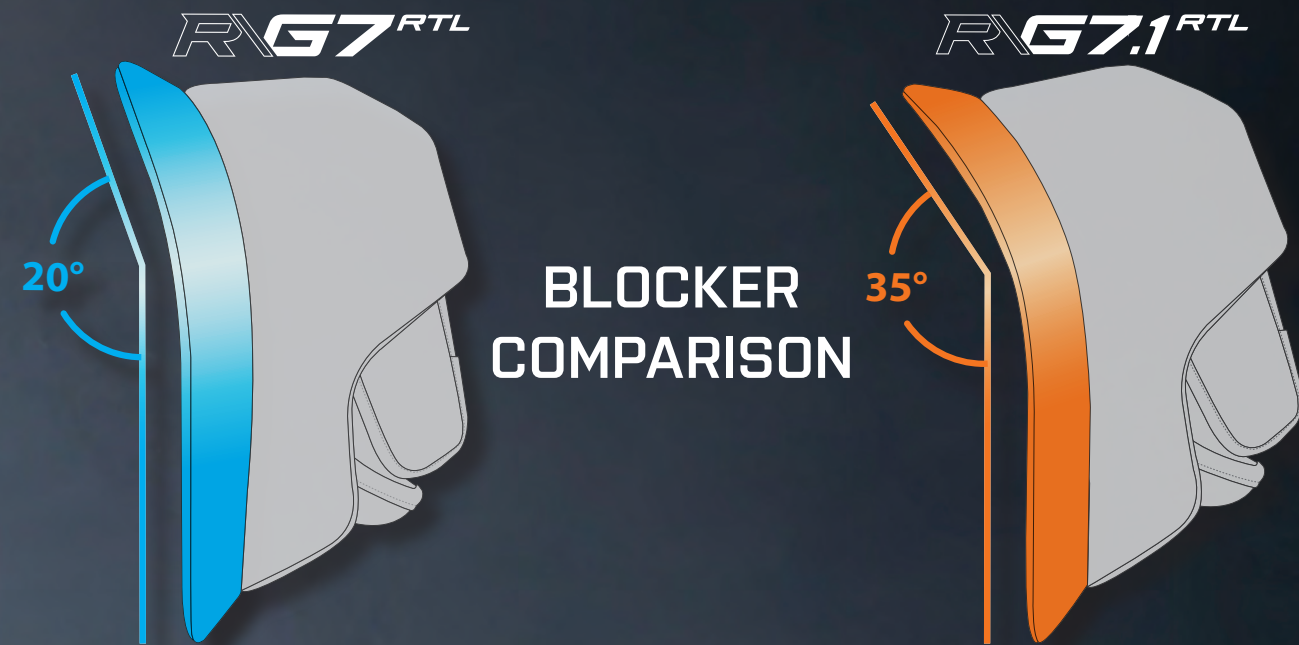

<p><i>low elevation</i> <i>high elevation</i></p> <p>Pucks are deflected high toward the glass</p>	<p>REBOUND ELEVATION</p>	<p><i>low elevation</i> <i>high elevation</i></p> <p>Pucks are deflected low toward the corner</p>
<p><i>low speed</i> <i>high speed</i></p> <p>Thicker board provides maximum rebound speed</p>	<p>REBOUND SPEED</p>	<p><i>low speed</i> <i>high speed</i></p> <p>Thinner board provides high rebound speed</p>
<p><i>less coverage</i> <i>more coverage</i></p> <p>Flatter board profile presents a larger surface to the shooter</p>	<p>COVERAGE</p>	<p><i>less coverage</i> <i>more coverage</i></p> <p>More curved board profile prevents puck skipover</p>
<p><i>less mobile</i> <i>more mobile</i></p> <p>Open cuff design for maximum wrist mobility</p>	<p>MOBILITY</p>	<p><i>less mobile</i> <i>more mobile</i></p> <p>Curved, thin board for maximum mobility in paddle down position</p>
<p><i>less weight</i> <i>more weight</i></p>	<p>WEIGHT</p>	<p><i>less weight</i> <i>more weight</i></p>

R\G7 RTL SR. BLOCKER



- 20 degree board shape improves rebound speed
- Enhanced wrist mobility
- Full range of motion finger guards
- X-Foam index finger protection
- HyperComp reinforced construction
- Adjustable side finger protection
- Removable and adjustable palm
- Adjustable contoured thumb and finger protection



REMOVABLE
BLOCKER LINER
INCLUDED

STYLE CODES | COLORS | SIZES

G7RB4	WWW (WHITE/WHITE/WHITE)	SR
G7RBF4	WBK (WHITE/BLACK)	
	BBB (BLACK/BLACK/BLACK)	
	WRD (WHITE/RED)	
	WBR (WHITE/BLACK/RED)	
	WRL (WHITE/ROYAL)	

BOOKING
ONLY

R\G7.1 RTL SR. BLOCKER



- 35 degree board shape improves rebound control
- Enhanced wrist mobility
- Full range of motion finger guards
- X-Foam index finger protection
- HyperComp reinforced construction
- Adjustable side finger protection
- Non-removable palm
- Adjustable contoured thumb and finger protection

STYLE CODES | COLORS | SIZES

G71RB4	WWW (WHITE/WHITE/WHITE)	SR
G71RBF4	WBK (WHITE/BLACK)	
	BBB (BLACK/BLACK/BLACK)	
	WRD (WHITE/RED)	
	WBR (WHITE/BLACK/RED)	
	WRL (WHITE/ROYAL)	

BOOKING
ONLY

R\G7 PRO SR. / INT. BLOCKER



- 20 degree board shape improves rebound speed and predictability
- Enhanced wrist mobility
- Full range of motion finger guards
- Increased index finger protection
- Adjustable side index finger protection
- CoverEDGE+ design
- Removable and adjustable palm
- Adjustable contoured thumb and finger protection



REMOVABLE
BLOCKER LINER
INCLUDED

STYLE CODES | COLORS | SIZES

SR G7PBS4	WWW (WHITE/WHITE/WHITE)	SR, INT
SR G7PBSF4	WBK (WHITE/BLACK)	
INT G7PBI4	BBB (BLACK/BLACK/BLACK)	
INT G7PBIF4	WRD (WHITE/RED)	
	WBR (WHITE/BLACK/RED)	
	WRL (WHITE/ROYAL)	

BOOKING
ONLY

R\G7.1 PRO SR. BLOCKER



- 35 degree board shape improves rebound control
- Enhanced wrist mobility
- Full range of motion finger guards
- Increased index finger protection
- Adjustable side index finger protection
- CoverEDGE+ design
- Non-removable palm
- Adjustable contoured thumb and finger protection

STYLE CODES | COLORS | SIZES

G71PBS4	WWW (WHITE/WHITE/WHITE)	SR (ONLY)
G71PBSF4	WBK (WHITE/BLACK)	
	BBB (BLACK/BLACK/BLACK)	
	WRD (WHITE/RED)	
	WBR (WHITE/BLACK/RED)	
	WRL (WHITE/ROYAL)	

BOOKING
ONLY

RITUAL X4 CHEST & ARM TECHNOLOGY

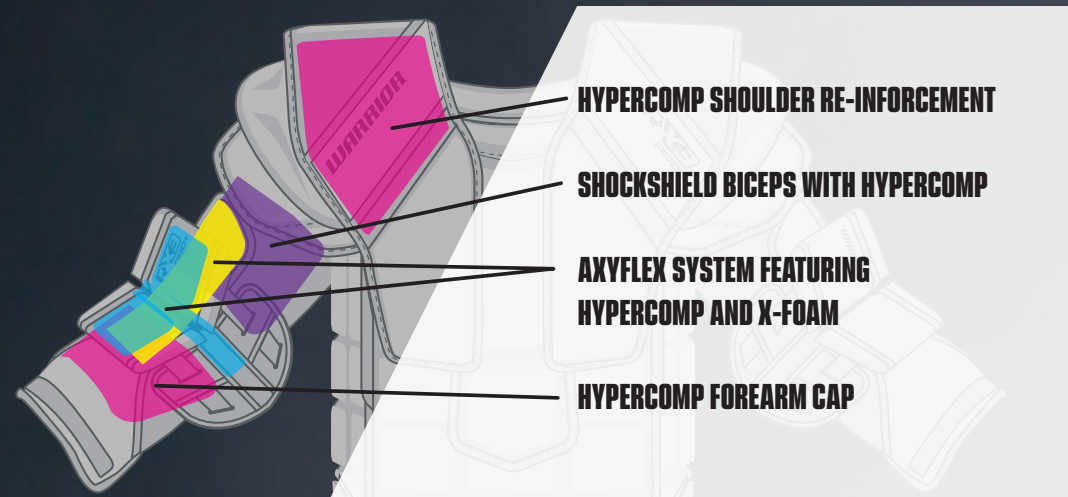

AXYFLEX SYSTEM

- HYPERCOMP CAP WITH XFOAM REINFORCEMENT
 CREATES BRIDGE PREVENTING ELBOW FLOATERS
 FROM CONTACTING ARM ON HEAVY IMPACTS

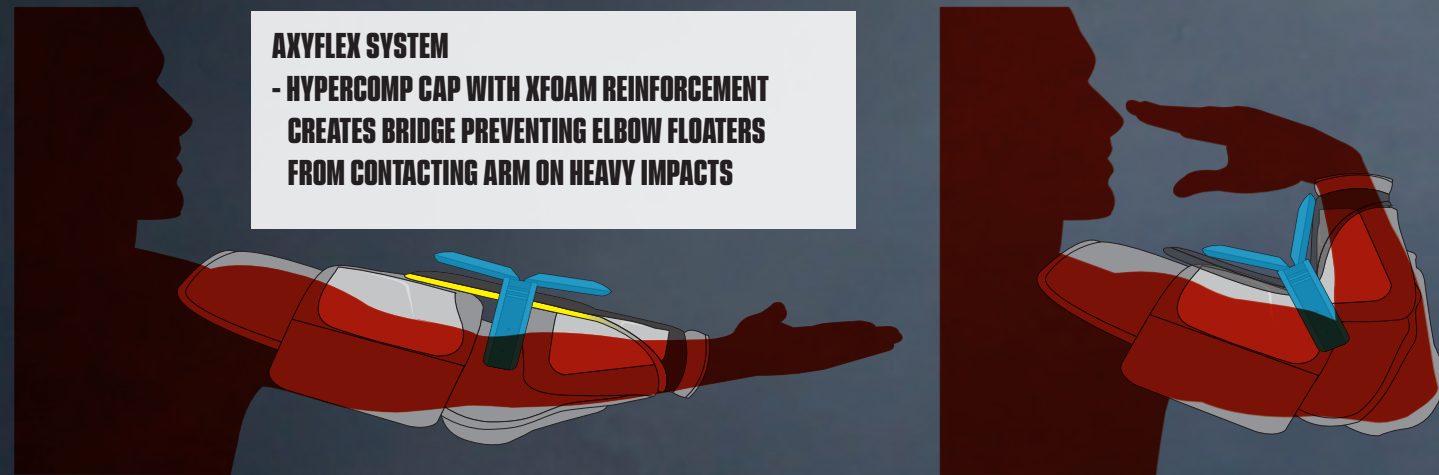

R\X4 PRO+ CHEST & ARM



- Superior protection using Shockshield design
- AxyFlex+ technology optimizes protection & mobility
- Maximum coverage shoulder floater design
- X-Foam and HyperComp reinforced protection
- Chest block design for maximum protection
- Side Velcro attachment
- Easy adjustment lace-in arm
- Removable front/side chest pad extensions
- Adjustable backplate settings

STYLE CODES | COLORS | SIZES

RX4CSPP3 BK (BLACK) S, M, L, XL

R\X4 PRO CHEST & ARM



- Shockshield bicep protection
- AxyFlex Light technology maximizes mobility.
- Streamline arms and shoulders for increased mobility.
- X-Foam and HyperComp reinforced protection
- Chest block design for maximum protection
- Side Velcro attachment
- Easy adjustment lace-in arm
- Removable front/side chest pad extensions
- Adjustable backplate settings

STYLE CODES | COLORS | SIZES

RX4CSP3 BK (BLACK) S, M, L, XL

R\X4 E+ CHEST & ARM



- AxyFlex technology balances protection & mobility
- Maximum coverage shoulder floater design
- Easy adjustment lace-in arm
- Removable front/side chest pad extensions
- Adjustable backplate settings

STYLE CODES | COLORS | SIZES

SR: **RX4CSEP3** BK (BLACK) S, M, L, XL
 INT: **RX4CIEP3** S/M, M/L, L/XL

R\X4 E CHEST & ARM



- AxyFlex Light technology maximizes mobility.
- Streamlined arms and shoulders for increased mobility.
- Lightweight design
- Easy adjustment velcro arm
- Adjustable backplate settings

STYLE CODES | COLORS | SIZES

RX4CSE3 BK (BLACK) SR: S, M, L, XL
RX4CIE3 INT: S/M, M/L, L/XL

R\X4 PRO+

 **RITUAL**



R\X4 PANTS



RITUAL X4 PANT TECHNOLOGY

FLEX PLATES



OVERLAPPING FLEX PLATES PROVIDE PRO LEVEL PROTECTION AND UNPRECEDENTED FLEXIBILITY AND MOBILITY

R\X4 PRO+ SR GOALIE PANTS



- Maximum protection
- Redesigned ergonomic hip and kidney protection.
- Streamlined thigh increases mobility.
- HyperComp reinforced Flex Plates
- AxyCut design
- Reinforced high wear areas
- Removable internal belt
- Durable and removable suspender buttons.

STYLE CODES | COLORS | SIZES

SR: **RX4PPP3** BK (BLACK) S, M, L, XL, 2XL

R\X4 E+ SR/INT/JR GOALIE PANTS



- Redesigned ergonomic hip and kidney protection.
- Lightweight design balances protection and mobility.
- Streamlined thigh increases mobility.
- Flex Plates
- AxyCut design
- Removable internal belt
- Durable and removable suspender buttons.

STYLE CODES | COLORS | SIZES

SR: **RX4PEP3** BK (BLACK) S, M, L, XL, 2XL
INT: **RX4PIEP3** S/M, M/L, L/XL

R\X4 E SR/INT/JR GOALIE PANTS



- Ultra lightweight
- No internal belt for conventional fit.
- AxyCut design
- Durable and removable suspender buttons.

STYLE CODES | COLORS | SIZES

SR: **RX4PE3** BK (BLACK) S, M, L, XL, 2XL
INT: **RX4PIE3** S/M, M/L, L/XL

RITUAL
PANTS

R\X4 PRO+ SR JOCK



- Pro level protection
- ShockShield technology
- Ergonomic abdomen pad

STYLE CODES | COLORS | SIZES

RX4JIEP3 BK (BLACK) OSZ



- Pro level protection
- ShockShield technology
- Ergonomic abdomen pad
- Removable and washable liner

STYLE CODES | COLORS | SIZES

RX4JSPP3 BK (BLACK) OSZ

R\X4 E+ INT JOCK R\X4 E JOCK



- Pro level protection
- ShockShield technology
- Ergonomic abdomen pad

STYLE CODES | COLORS | SIZES

RX4JIEP3 BK (BLACK) OSZ



- Lightweight and protective
- Ergonomic abdomen pad
- Soft cushioned liner

STYLE CODES | COLORS | SIZES

SR: RX4JSE3 BK (BLACK) OSZ
INT: RX4JIE3

R\X4 PRO COLLAR



- X-Foam maximizes protection
- Stretch fabric for excellent comfort
- Ergonomic and secure fit
- Maximum coverage

STYLE CODES | COLORS | SIZES

RX4CP3 BK (BLACK) OSZ

R\X4 E+ COLLAR



- Super lightweight design
- Conventional fit

STYLE CODES | COLORS | SIZES

RX4CEP3 BK (BLACK) OSZ

R\X4 PRO+ KNEE PADS



- Wide profile for maximum protection and coverage
- HyperComp reinforced knee plate
- Four piece construction
- Optimized shock absorbing landing area
- No Slip design

STYLE CODES | COLORS | SIZES

RX4KSPP3 BK (BLACK) OSZ

R\X4 PRO KNEE PADS



- Narrow profile for balanced protection and coverage
- Optimized shock absorbing landing area
- Four piece construction
- No Slip design

STYLE CODES | COLORS | SIZES

RX4KSP3 BK (BLACK) OSZ

R\X4 E+ KNEE PADS



- Narrow profile for protection and mobility.
- Comfortable knee landing area
- Three piece construction
- No Slip design

STYLE CODES | COLORS | SIZES

SR: RX4KSEP3 BK (BLACK) OSZ
INT: RX4KIEP3

R\X4 E KNEE PADS



- Two piece construction
- Protective and mobile
- Comfortable knee landing area
- No Slip design

STYLE CODES | COLORS | SIZES

SR: RX4KSE3 BK (BLACK) OSZ
INT: RX4KIE3

R\G7 TRAPPER LINER



- Removable trapper liner - Compatible with G3, G4, G5, G6, and G7 trappers
- 60, 75 or 90 Degree break angle (SR Only)
- Velcro attachment
- Practice palm insert (SR Only)

STYLE CODES | COLORS | SIZES

SR: 60: **G7STL604** GR (GREY) OSZ
 60: **G7STL754**
 60: **G7STL904**
 INT: 75: **G7ITL754**

R\G7 BLOCKER PALM



- Removable blocker palm - Compatible with G3, G4, G5, G6, and G7 blockers
- 4 different sizes (INT, MD, LG, XL)
- Easy removable strap system
- Velcro attachment

STYLE CODES | COLORS | SIZES

SR: **G7SBL4** GR (GREY) OSZ
 INT: **G7IBL4**

R\G7 TOE BOX KIT

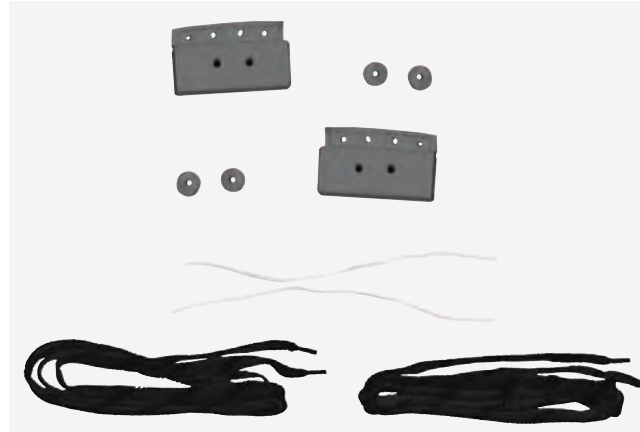

- 2 HD toe box
- 2 Skate laces
- 2 Nylon laces

STYLE CODES | COLORS | SIZES

G7TOEBR4 GR (GREY) OSZ

R\G7 LEG PAD CARRY STRAP



- 1 Polypropylene carry strap
- Compatible with all Ritual leg pads

STYLE CODES | COLORS | SIZES

G7LPCAR4 BK (BLACK) OSZ

R\G7 ELASTIC STRAP KIT

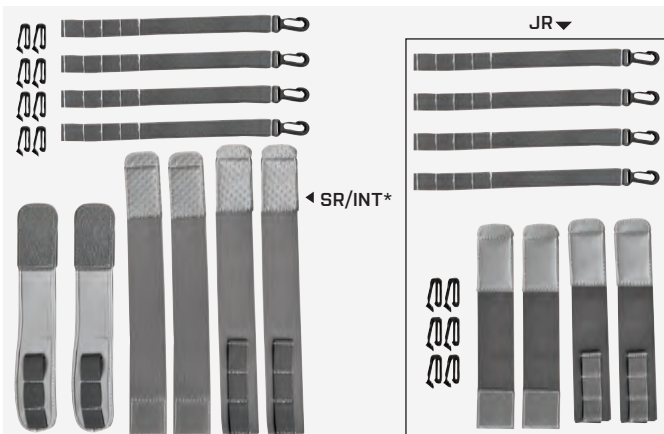

- 2 G7 Sling elastic knee straps
- 2 G7 elastic calf wrap straps*
- 2 G7 neoprene Sling Wrap top calf straps (Senior)
- 4 G7 Active Response toe/heel straps
- 8 Slik-Clips (Senior)
- 6 Slik-Clips (Junior)
- Compatible with G3, G4, G5, G6, G7 Leg Pads

STYLE CODES | COLORS | SIZES

SR/INT: **G7ESKS4** GR (GREY) OSZ

R\G7 SLIDE PLATE KIT



- 2 Polycarbonate slider plates
- Fits Senior and Intermediate G7 Leg Pads

STYLE CODES | COLORS | SIZES

SR/INT: **G7SPLTS4** CLR (CLEAR) SR, INT

R\G7 ELASTIC KNEE STRAP KIT



- Intergrates all Ritual goalie jocks with all Ritual Knee Pads

STYLE CODES | COLORS | SIZES

RITEKPS9 GR (GREY) OSZ

R\G7 LEATHER BOOT STRAP KIT



- 2 long leather boot straps
- 2 leather buckle attachments
- 2 brass buckles
- 4 screws
- Compatible with Ritual G series leg pads

STYLE CODES | COLORS | SIZES

RITLSK8 BK (BLACK) OSZ

LEG PAD SIZING CHART

Take this measurement while sitting
Prendre cette mesure en position assise

Knee Pivot Point
Point de pivot du genou

Floor
Plancher

11"
10.5"
10"
9.5"
9"
8.5"
8"

PAD SIZE/ GRANDEUR	19"	21"	23"	24"	26"	28"	30"	31"	32"	33"	34"	35"	36"	37"	38"
A FLOOR TO KNEE MEASUREMENT, RANGE (IN.)	12.75" &-	12.75" - 13.75"	13.75" - 14.75"	14.75" - 15.75"	15.75" - 16.75"	16.75" - 17.75"	17.75" - 18.25"	18.25" - 18.75"	18.75" - 19.25"	19.25" - 19.75"	19.75" - 20.25"	20.25" - 20.75"	20.75" - 21.25"	21.25" - 21.75"	21.75" &+
MESURE DU PLANCHER AU GENOU, FOURCHETTE(mm)	324 &-	325 - 349	350 - 375	376 - 400	401 - 425	426 - 451	452 - 463	464 - 476	477 - 489	490 - 502	503 - 514	515 - 527	528 - 540	541 - 552	553 &+
B BODY HEIGHT	3'9" &-	3'11"	4'2"	4'5"	4'8"	4'10.5"	5'	5'4"	5'6"	5'8"	5'10.5"	6'	6'1.5"	6'3"	6'3" &+
HAUTEUR	1m14	1m19	1m27	1m35	1m42	1m49	1m52	1m63	1m66	1m73	1m79	1m83	1m87	1m91	1m92 &+
C LENGTH OF EXTENSION ABOVE KNEE CAP (+)	8" 8.5" 9"								+0.5" +1"	0 +0.5"	0 +0.5"	N/A 0	N/A 0	N/A 0	N/A 0
MESURE DE LA JAMBIÈRE AU DESSUS DE LA ROTULE (+)	9.5" 10" 10.5" 11"								+1.5" +2"	+1" +1.5"	+1" +1.5"	+0.5" +1"	+0.5" +1"	0 +0.5"	0 +0.5"

CHEST & ARM SIZING CHART

ARM SPAN (IN.)
ENVERGURE DES BRAS (cm)

		ARM SPAN (IN.)	ENVERGURE DES BRAS (cm)
PRO	XL	76" +	1m93+
	L	73" - 76"	1m85 - 1m93
	M	70" - 73"	1m78 - 1m85
SENIOR	S	67" - 70"	1m70 - 1m78
	XL	72" +	1m83+
	L	69" - 74"	1m75 - 1m88
INT.	M	66" - 72"	1m68 - 1m83
	S	64" - 69"	1m60 - 1m75
	L-XL	64" - 69"	1m62 - 1m75
JUNIOR	M-L	63" - 68"	1m60 - 1m73
	S-M	60" - 65"	1m52 - 1m65
	L-XL	54" - 61"	1m37 - 1m55
YOUTH	S-M	51" - 56"	1m30 - 1m42
	L-XL	45" - 55"	1m14 - 1m40
	S-M	39" - 49"	99 - 1m24

GOALIE PANTS SIZING CHART

SIZE	HIP TO KNEE		WAIST SIZE		
	IN.	cm	IN.	cm	
PRO	XXL	19"+	48+	38" - 40"	97 - 102
	XL	19"+	48+	30" - 38"	76 - 97
	L	18" - 19"+	46 - 48	30" - 38"	76 - 97
	M	17" - 18"+	43 - 46	30" - 38"	76 - 97
	S	16" - 17"+	40 - 43	30" - 38"	76 - 97

SIZE	BODY HEIGHT		
	IN.	m	
INT	XXL	5'4" - 5'9"	1m62 - 1m75
	L - XL	5'3" - 5'8"	1m60 - 1m73
	S - M	5'0" - 5'5"	1m52 - 1m65
JUNIOR	L - XL	4'6" - 5'1"	1m37 - 1m55
	S - M	4'3" - 4'8"	1m30 - 1m42

TRAPPER / BLOCKER SIZING CHART

HEEL OF PALM TO TIP
OF MIDDLE FINGER
-
MESURE DU TALON DE LA
MAIN JUSQU'AU BOUT DU MAJEUR

	SENIOR	INT	JUNIOR	YTH
HAND SIZE (IN.)	8.5" - 7"	7" - 6.35"	6.35" - 5.75"	5.75" - 4.5"
MESURE DE LA MAIN (mm)	216 - 179	178 - 161	160 - 144	143 - 119
	XL	LRG	MED	
HAND SIZE (IN.)	8.5" - 8"	8" - 7.5"	7.5" - 7"	
MESURE DE LA MAIN (mm)	216 - 203	203 - 190	190 - 179	

R/M3^{RTL}



R/M3 STICK TECHNOLOGY

Ultra light-weight Minimus construction features an innovative geometry that drives flex energy towards a lower kick point. This provides a quicker release when making passes and elevating the puck in tight areas around the net.



MINIMUS GEOMETRY



ASYMMETRICAL
SHAFT GEOMETRY



GOALIE BLADE PATTERN CHART

W32	W33	W34
Mid curve, medium depth, slightly open with a square toe.	Mid-twist curve, deep depth, slightly open with a square toe.	Wedge, medium depth, open with a round toe.
SIMILAR TO: Bauer: P34, P20 True: MC2	SIMILAR TO: CCM: P4 (182-2) Bauer: P31 True: TC	SIMILAR TO: CCM: P1 (142-3) True: PC2

R\M3 RTL

- Extremely lightweight goalie stick.
- Asymmetrical Shaft Geometry
- Minimus construction for low kick point
- Minimus Carbon 25 paddle and blade
- Minimus UD shaft
- SlideGrip Technolog
- Mirror chrome details with glossy paddle and blade finish
- Industry standard paddle lengths

OFFERINGS

<u>SENIOR - LEFT</u>	<u>SENIOR - RIGHT</u>
SR 26"	SR 26"
W33	W33
M3R26L4	M3R26R4

SR 25"	SR 25"
W33	W33
M3R25L4	M3R25R4

SR 24"	SR 24"
W33	W33
M3R24L4	M3R24R4

<u>INTERMEDIATE - LEFT</u>	<u>INTERMEDIATE - RIGHT</u>
INT 23"	INT 23"
W33	W33
M3R23IL4	M3R23IR4

CUSTOM AVAILABLE ON

www.warrior.com

(SENIOR & INTERMEDIATE)

COLORS

BK (BLACK)

PATTERNS

W33 (TWT)



R\M3 PRO

- Asymmetrical Shaft Geometry (Senior & Intermediate)
- Minimus Carbon 12
- Minimus construction for low kick point (Senior & Intermediate)
- Quick release shooting & passing
- SlideGrip technology
- Mirror chrome details
- Glossy paddle & blade finish
- Industry standard paddle lengths

OFFERINGS

<u>SENIOR - LEFT</u>	<u>SENIOR - RIGHT</u>
SR 26"	SR 26"
W33	W33
M3P26L4	M3P26R4

SR 25"	SR 25"
W33	W33
M3P25L4	M3P25R4

SR 24"	SR 24"
W33	W33
M3P24L4	M3P24R4

<u>INTERMEDIATE - LEFT</u>	<u>INTERMEDIATE - RIGHT</u>
INT 23"	INT 23"
W33	W33
M3P23IL4	M3P23IR4

CUSTOM AVAILABLE ON

www.warrior.com

(SENIOR & INTERMEDIATE)

COLORS

BK (BLACK)

PATTERNS

JR: W32 (MID)

SR/INT: W33 (TWT)

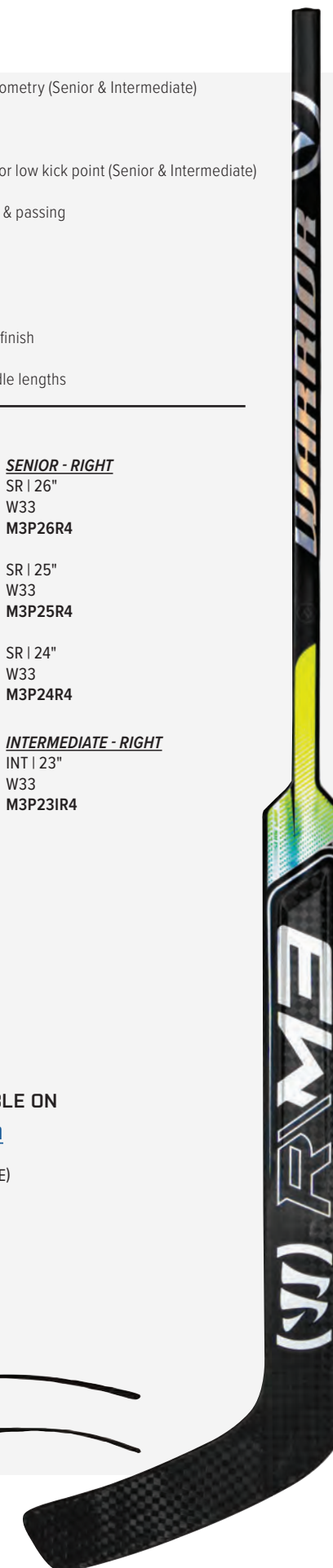

R\M3

- Minimus Carbon
- Minimus construction for low kick point & quick release (Senior & Intermediate)
- Conventional shaft geometry
- SlideGrip technology
- HiFused Construction – Super light balanced feel
- Impact Fiber Layer Shaft – Enhanced shaft durability
- Glossy paddle finish
- Industry standard paddle lengths

OFFERINGS

<u>SENIOR - LEFT</u>	<u>SENIOR - RIGHT</u>
SR 26"	SR 26"
W33	W33
M326L4	M326R4

SR 25"	SR 25"
W33	W33
M325L4	M325R4

SR 24"	SR 24"
W33	W33
M324L4	M324R4

<u>INTERMEDIATE - LEFT</u>	<u>INTERMEDIATE - RIGHT</u>
INT 23.5"	INT 23.5"
W33	W33
M323IL4	M323IR4

COLORS

BK (BLACK)

PATTERNS

JR: W32 (MID)

SR/INT: W33 (TWT)

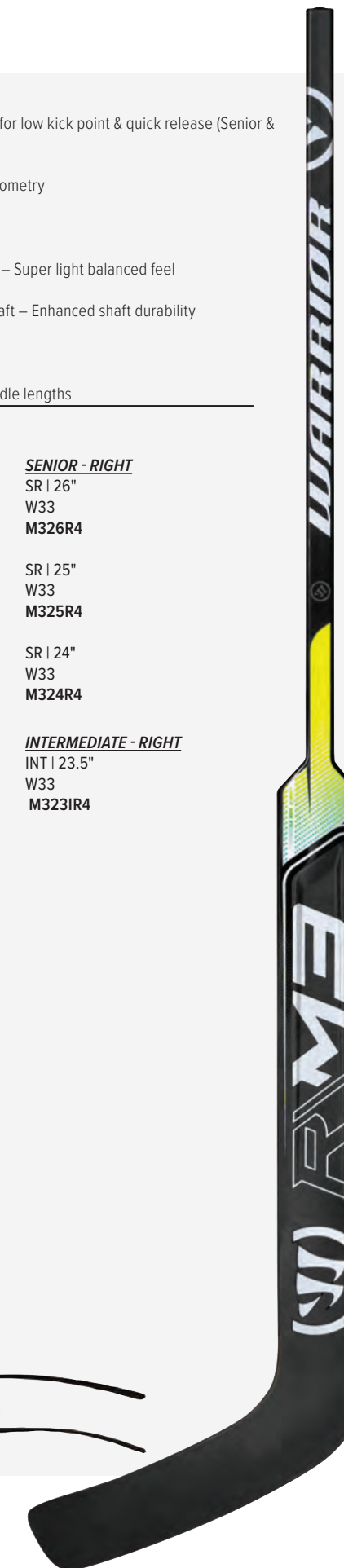

RITUAL
STICKS



R/V3 STICK TECHNOLOGY

A mid-flex goal stick that makes transferring flex energy through the stick easy for maximum shooting power and stability. This gives more power and control for hard tape-to-tape passes and long distance plays to clear the defensive zone.

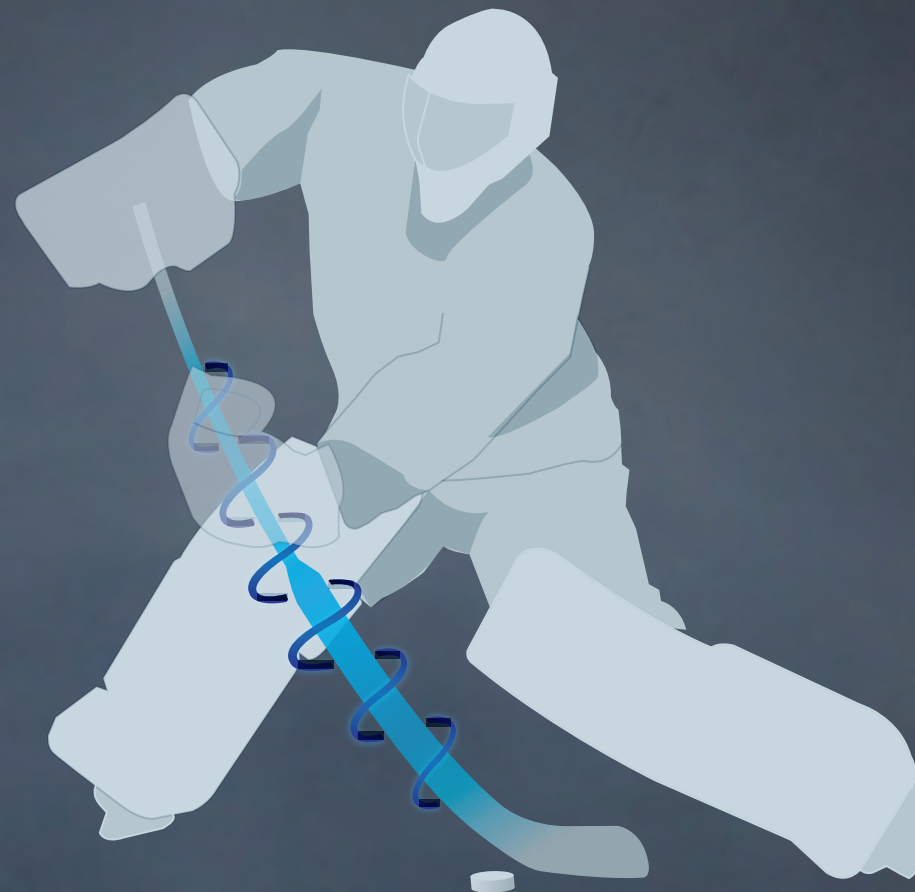

R/V3 PRO+

- Easy loading mid-flex profile maximizes shooting power
- Minimus Carbon 25
- SlideGrip Technology
- VibexLite - Vibration Reduction Technology
- Hi-Fused Construction - Super light balanced feel
- Impact Fiber Layer - Enhanced shaft durability
- TwinSpar Paddle Reinforcement for increased stability

OFFERINGS

<u>SENIOR - LEFT</u>	<u>SENIOR - RIGHT</u>
SR 27.5"	SR 27.5"
W32, W33, W34	W32
V3PP27L3	V3PP27R3
SR 26"	SR 26"
W32, W33, W34	W32
V3PP26L3	V3PP26R3
SR 25"	SR 25"
W32, W33, W34	W32
V3PP25L3	V3PP25R3
<u>INTERMEDIATE - LEFT</u>	<u>INTERMEDIATE - RIGHT</u>
INT 23.5"	INT 23.5"
W32, W34	W32
V3PPI3L3	V3PPI3R3

COLORS
WBK (WHITE/BLACK)

CUSTOM AVAILABLE ON
www.warrior.com
(SENIOR & INTERMEDIATE)

PATTERNS
W32 (MID)
W33 (TWT)
W34 (WDG)

R/V3 PRO

- Easy loading mid-flex profile maximizes shooting power
- Minimus Carbon 12
- SlideGrip Technology
- VibexLite - Vibration Reduction Technology
- Hi-Fused Construction - Super light balanced feel
- Impact Fiber Layer - Enhanced shaft durability
- TwinSpar Paddle Reinforcement for increased stability

OFFERINGS

<u>SENIOR - LEFT</u>	<u>SENIOR - RIGHT</u>
SR 27.5"	SR 27.5"
W32, W33, W34	W32
V3P27L3	V3P27R3
SR 26"	SR 26"
W32, W33, W34	W32
V3P26L3	V3P26R3
SR 25"	SR 25"
W32, W33, W34	W32
V3P25L	V3P25R3
<u>INTERMEDIATE - LEFT</u>	<u>INTERMEDIATE - RIGHT</u>
INT 23.5"	INT 23.5"
W32, W34	W33
V3PI3L3	V3PI3R3

COLORS
WBK (WHITE/BLACK)

CUSTOM AVAILABLE ON
www.warrior.com
(SENIOR & INTERMEDIATE)

PATTERNS
W32 (MID)
W33 (TWT)
W34 (WDG)



GOALIE BLADE PATTERN CHART

W32



Mid curve, medium depth, slightly open with a square toe.

SIMILAR TO:
Bauer: P34, P20
True: MC2

W33



Mid-twist curve, deep depth, slightly open with a square toe.

SIMILAR TO:
CCM: P4 (182-2)
Bauer: P31
True: TC

W34



Wedge, medium depth, open with a round toe.

SIMILAR TO:
CCM: P1 (142-3)
True: PC2

R\F2 PRO

XFOAM

OUR MOST ADVANCED IMPACT ABSORBING FOAM PROVIDES A TARGETED BARRIER ON IMPACTS TO THE FOREHEAD AND WORKS IN CONJUNCTION WITH THE OUTER SHELL TO PROTECT AGAINST INJURY.

IMPAX FOAM

DUAL DENSITIES OF OUR PREMIUM IMPACT ABSORBING FOAM PROVIDE THE OPTIMAL BALANCE OF PROTECTION, COMFORT AND WEIGHT REDUCTION.

FANTOM FIT

ULTIMATE COMFORT ACHIEVED THROUGH OPTIMUM FIT CHARACTERISTICS.

OMNISHOCK+ SYSTEM

A HOLISTIC APPROACH TO HEAD PROTECTION FOCUSED ON SAFETY FIRST. ALL SHELL AND LINER COMPOSITIONS ARE INTEGRATED BY DESIGN. A COMBINATION OF X FOAM AND DUAL-DENSITY MOLDED IMPAX FOAMS, THE OMNISHOCK+ DESIGN PROVIDES ULTIMATE PROTECTION AGAINST PUCK IMPACTS AND COLLISIONS WITHIN THE CREASE.

CHIN MOBILITY

THE R/F2 CHIN MAXIMIZES MOBILITY WITHOUT SACRIFICING PROTECTION SO THE GOALIE CAN EFFICIENTLY MOVE THEIR HEAD WITH MINIMAL CHEST PROTECTOR INTERFERENCE. THIS MAKES TRACKING PUCKS INTO THE BODY AND WATCHING PLAYS BEHIND THE NET EFFORTLESS.

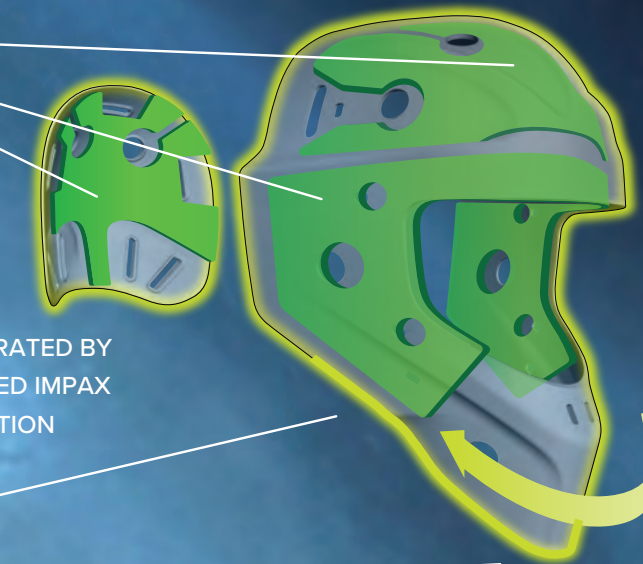
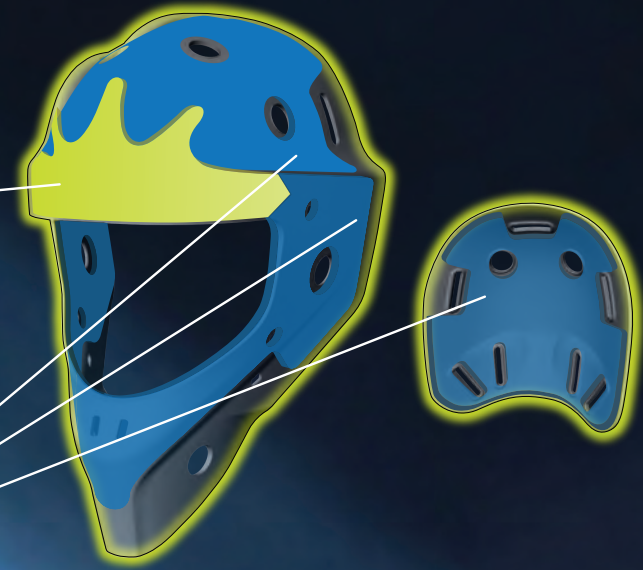

RITUAL
ELEVATE YOUR GAME

R\F2 PRO MASK (CERTIFIED/NON-CERTIFIED)



- FantomFIT - Optimal fit characteristics
- IMPAX and X-Foam combine for maximum impact protection.
- OMNISHOCK+ includes molded dual density foams for comfort and protection.
- Minimus Carbon 20 - Super strong and lightweight shell
- Polygiene sweatband reduces odor
- Optimized chin mobility
- Easy adjustable chin cup
- Invisible backplate strap system
- Padded mask bag included
- Certified stainless square cage
- Certified cat eye stainless cage
- Non-certified cat eye stainless cage



STYLE CODES | COLORS | SIZES

F2PCSQ3	WH (WHITE)	S/M, M/L, L/XL	Certified square bar
F2PCCE3	WH (WHITE)	S/M, M/L, L/XL	Certified cat eye
F2PNCE3	WH (WHITE)	S/M, M/L, L/XL	Non-certified cat eye

R\F2 E+ SR. MASK (CERTIFIED/NON-CERTIFIED)



- FantomFIT - Optimal fit characteristics
- IMPAX and X-Foam combine for maximum impact protection.
- OMNISHOCK+ includes molded dual density foams for comfort and protection.
- Minimus Carbon UD - Added shell strength and durability
- Polygiene sweatband reduces odor
- Optimized chin mobility
- Easy adjustable chin cup
- Traditional backplate strap system
- Padded mask bag included
- Certified stainless square cage
- Certified cat eye stainless cage
- *Non-certified cat eye stainless cage sold separately



STYLE CODES | COLORS | SIZES

F2EPSSQ3	WH (WHITE)	S/M, M/L, L/XL	Certified square bar
F2EPSCE3	WH (WHITE)	S/M, M/L, L/XL	Certified cat eye
F2EPSNCE3	WH (WHITE)	S/M, M/L, L/XL	Non-certified cat eye

R\F2 E SR. MASK (CERTIFIED)



- FantomFIT – Optimal fit characteristics
- IMPAX foam for added protection.
- OMNISHock includes molded dual density foams for comfort and protection.
- Polygiene sweatband reduces odor
- Optimized chin mobility
- Easy adjustable chin cup
- Traditional backplate strap system
- Padded mask bag included
- Certified stainless square cage
- Certified cat eye stainless cage



DANGLER INCLUDED



ADDITIONAL SWEATBAND INCLUDED

STYLE CODES | COLORS | SIZES

F2ESCSQ3	(WHITE)	S/M, M/L	Certified square bar
F2ESCCE3	WH (WHITE)	S/M, M/L	Certified cat eye



R\F2 MASK SIZING CHART

R\F2 PRO / E+ SR	HAT SIZE	CM
S/M	6 7/8 - 7 1/4	55 - 58
M/L	7 - 7 3/8	56 - 59
L/XL	7 1/8 - 7 1/2	57 - 60

R\F2 E SR	HAT SIZE	CM
S/M	6 7/8 - 7 3/8	55 - 58.5
M/L	7 - 7 1/2	56 - 59.5

R\F2 E+ JR / E JR	HAT SIZE	CM
O/S	6 5/8 - 7 1/8	53 - 57

R\F2 E YTH	HAT SIZE	CM
O/S	6 1/8 - 6 3/4	49 - 54

R\F2 CAGE COMPATIBILITY CHART

		R\F2 WIRE CAGE SIZE				
R\F2 MASK	MODEL	SIZE	Size 1	Size 2	Size 3	Size 4
	PRO	S/M		●		
	PRO	M/L	●			
	PRO	L/XL	●			
	E+ SR	S/M		●		
	E+ SR	M/L	●			
	E+ SR	L/XL	●			
	E SR	S/M	●			
	E SR	M/L	●			
	E+ JR	O/S			●	
	E JR	O/S			●	
	E YTH	O/S				●

		R\F2 WIRE CAGE MODEL		
R\F2 MASK	MODEL	CERTIFIED SQUARE BAR	CERTIFIED CAT EYE	NON-CERTIFIED CAT EYE
	PRO	CSQ NS	CCE NS	NCE NS NCE WS
	E+ SR	CSQ NS	CCE NS	NCE NS NCE WS
	E SR	CSQ NS CSQ CC	CCE NS	NCE NS NCE WS
	E+ JR	CSQ NS	CCE NS	
	E JR	CSQ NS CSQ CC	CCE NS	
	E YTH	CSQ GC CSQ CC		

R\F2 MASK DANGLER



- Clear dangler
- 3 Pre-cut laces

STYLE CODES | SIZES | COLORS
F2DNG3 OSZ CLR (CLEAR)

R\F2 HARDWARE KIT

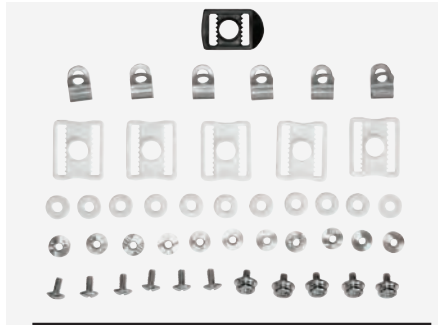

- 6 Cage screws
- 6 Cage clips
- 11 Washers
- 5 Harness strap clips
- 5 Combined screw snaps
- 9 Short T-Nuts
- 2 Tall T-Nuts with grooves
- 1 Chin strap buckle

STYLE CODES | SIZES | COLORS
F2HWK3 OSZ NONE

R\F2 TRADITIONAL HARNESS KIT

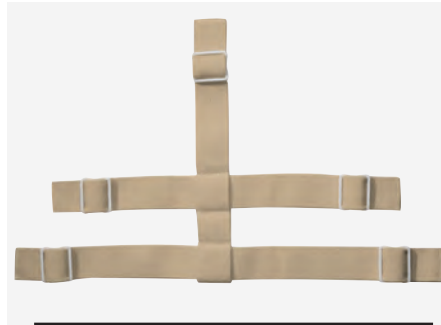

- Elastic harness straps
- 5 Harness strap clips

STYLE CODES | SIZES | COLORS
F2HT3 OSZ NONE

R\F2 REPLACEMENT SQUARE BAR CAGE



- HECC certified
- Stainless steel finish
- 6 Cage screws
- 6 Cage clips
- 6 Cage washers
- 6 Short T-Nuts
- 2 Clear plastic tubes

STYLE CODES | SIZES | NOTES
F2CSQC3 SZ1 Fits Senior sized masks L/XL & M/L
 SZ2 Fits Senior sized masks S/M

R\F2 REPLACEMENT CERTIFIED CAT EYE CAGE

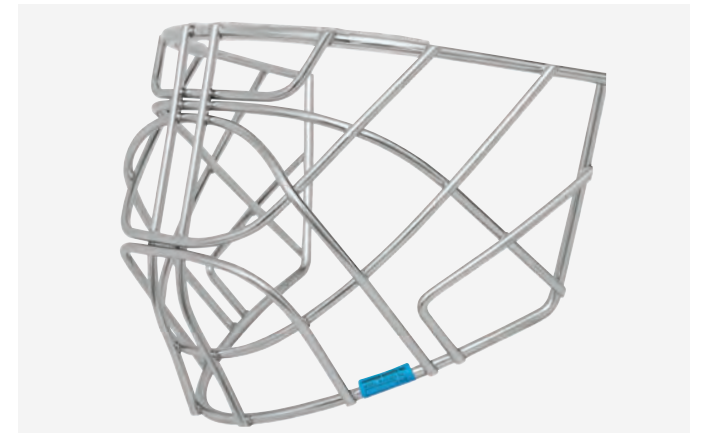

- HECC certified
- Chrome steel finish
- 6 Cage screws
- 6 Cage clips
- 6 Cage washers
- 6 Short T-Nuts
- 2 Clear plastic tubes

STYLE CODES | SIZES | NOTES
F2CCEC3 SZ1 Fits Senior sized masks L/XL & M/L
 SZ2 Fits Senior sized masks S/M

R\F2 INVISIBLE HARNESS KIT



- 5 Elastic harness straps
- 5 Harness strap clips

STYLE CODES | SIZES | COLORS
F2HI3 OSZ NONE

R\F2 CHIN CUP



- 1 Chin cup
- Chin cup straps
- 2 Combined screw snaps
- 2 Tall T-Nuts with grooves
- 2 Washers
- Chin strap and buckle

STYLE CODES | SIZES | COLORS
F2CC3 OSZ BK (BLACK)

R\F2 SWEATBAND KIT



- 2 Sweatbands
- Polygiene sweat bands
- Sweat absorbent
- *SR is compatible with JR sized masks

STYLE CODES | SIZES | COLORS
F2SBK3 SR BK (BLACK)

R\F2 REPLACEMENT NON-CERTIFIED CAT EYE CAGE

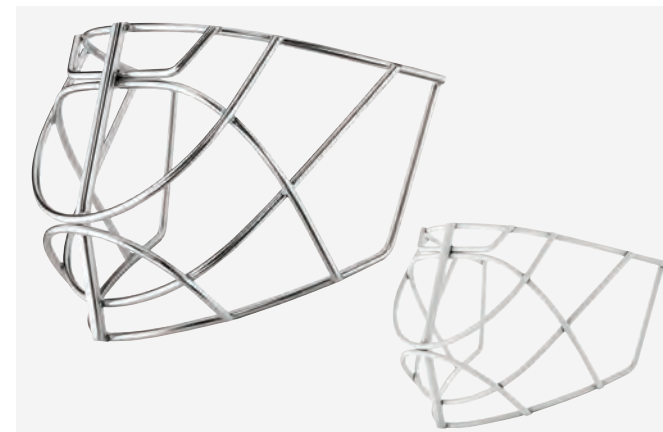

- Pro cat eye design
- Stainless steel finish
- 6 Cage screws
- 6 Cage clips
- 6 Cage washers
- 6 Short T-Nuts
- 2 Clear plastic tubes

STYLE CODES | SIZES | COLORS
F2NCEC3 SZ1 STN (STAINLESS)
 SZ2 WH (WHITE)
 SZ1 = Fits Senior sized masks L/XL & M/L
 SZ2 = Fits Senior sized masks S/M



NORTH AMERICA

WARRIOR SPORTS

7080 23 MILE RD.

SHELBY TOWNSHIP, MI. 48316 | U.S.A.

U.S. CUSTOMER SERVICE:

TEL: 800.968.7845

FAX: 586.446.1162

EMAIL: orders@warrior.com

CANADA CUSTOMER SERVICE:

TEL: 866.966.6092

FAX: 586.446.1162

EMAIL: orders@warrior.com

EUROPE

WARRIOR SPORTS INC.

NORDSTRASSE 2

87616 MARKTOBERDORF | GERMANY

PHONE: +49 8342 897000

FAX: +49 8342 8970090

VISIT
WARRIOR.COM
TO LEARN MORE



WARRIORHOCKEY



@WARRIORHKY



@WARRIORHOCKEY



@WARRIORHKY

WARRIOR®